

PORTUGUÊS

ATOM X



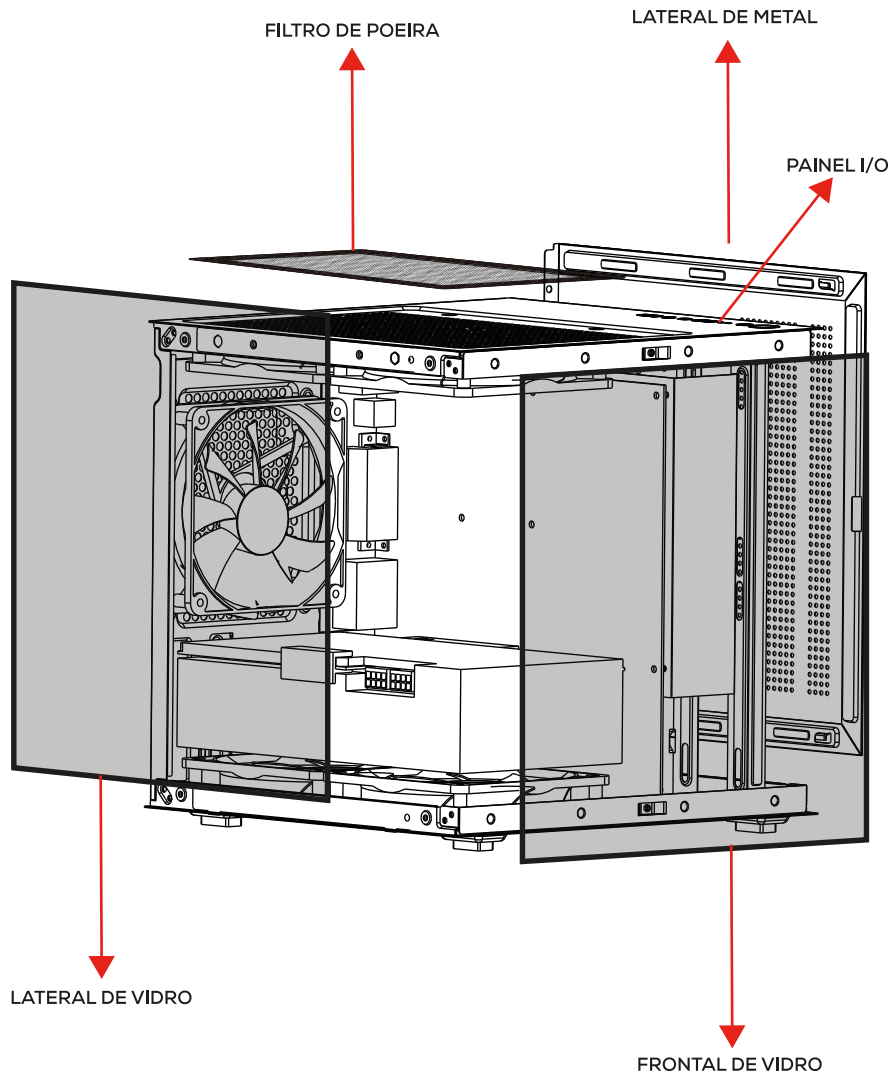

IMPORTANTE

É DE EXTREMA IMPORTÂNCIA LER, COMPREENDER E SEGUIR TODAS AS INSTRUÇÕES CONTIDAS NESTE MANUAL. O MANUSEIO INCORRETO PODE DANIFICAR O EQUIPAMENTO E OCASIONAR A ANULAÇÃO DA GARANTIA.

COMPONENTES DO HARDWARE



ACESSÓRIOS

Item	Nome/Quant.	Utilidade
	Parafusos #6-32 6mm x5	Fonte de Alimentação e Placa de Vídeo
	Parafusos M3 5mm x11	Placa-Mãe e SSD 2.5"
	Parafusos #6-32 5mm x4	HDD 3.5"
	Espaçadores #6-32 6.5mm x2	Suporte para Placa-Mãe

ABERTURA DO GABINETE

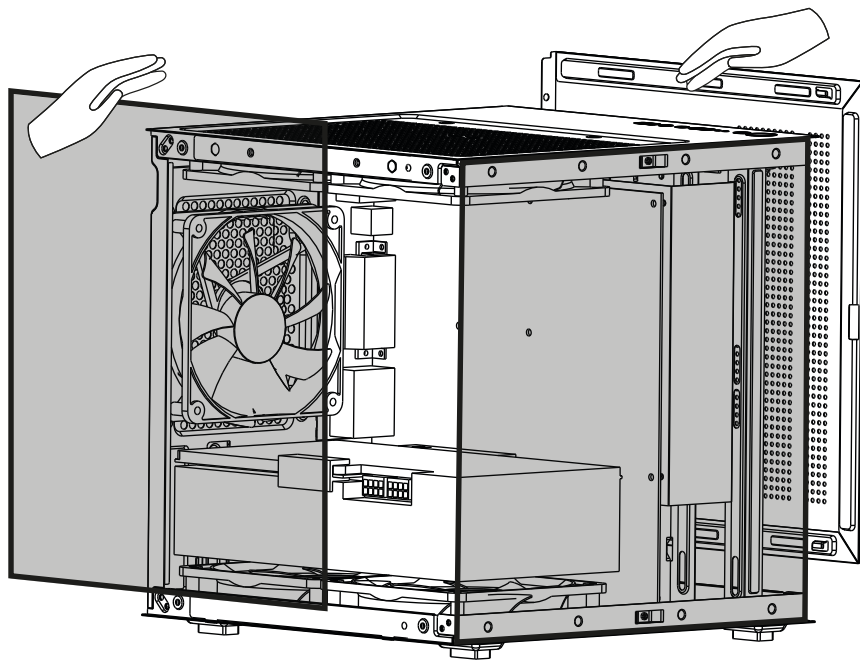

Desparafuse e reserve os parafusos localizados na parte traseira ou lateral do gabinete, então remova as laterais.

INSTALAÇÃO DA PLACA-MÃE

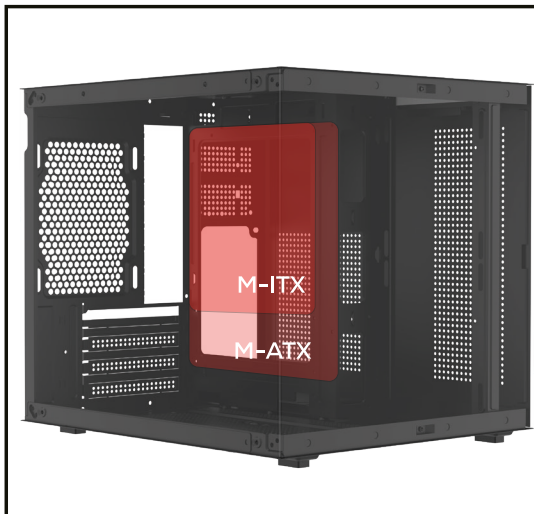

Posicione a Placa-Mãe alinhando suas furações com as do local de instalação, reposicione os espaçadores se necessário, e fixe com os respectivos parafusos.

INSTALAÇÃO DE HDD 3.5" E SSD 2.5"

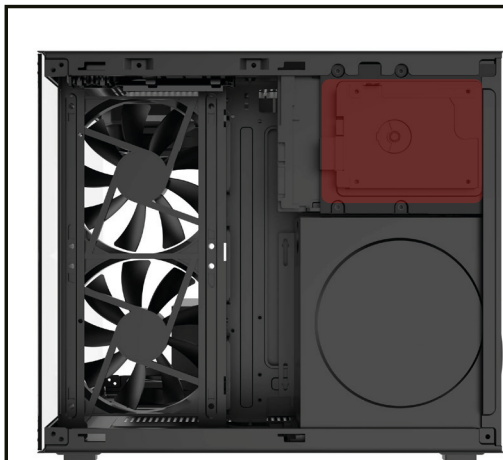

Posicione o HDD/SSD alinhando suas furações com as do local de instalação, e fixe com os respectivos parafusos.

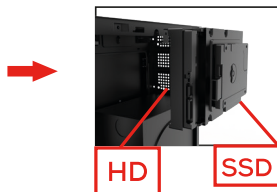

INSTALAÇÃO DAS VENTONHAS

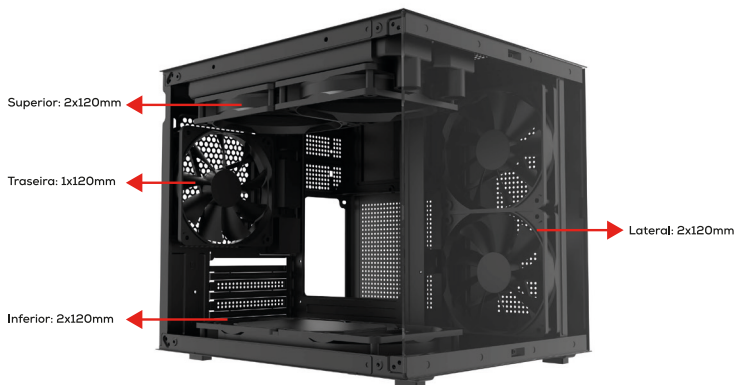

Posicione a Ventoinha/Water Cooler alinhando suas furações com a do local de instalação, e fixe com os respectivos parafusos.

INSTALAÇÃO DA FONTE DE ALIMENTAÇÃO

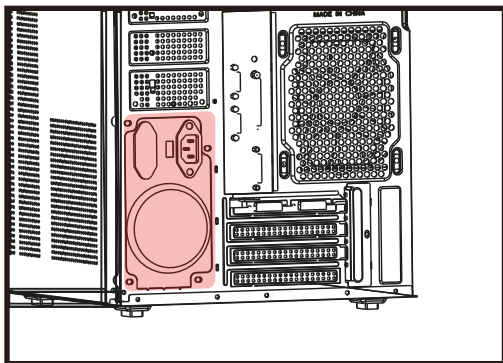

Remova a lateral de metal para ter acesso ao local de instalação, posicione a Fonte de Alimentação alinhando suas furações com o local de instalação, e fixe com os respectivos parafusos pela parte traseira do gabinete.

INSTALAÇÃO DA PLACA DE VÍDEO



Identifique e remova os slots de expansão que o modelo da Placa de Vídeo irá utilizar, conecte a Placa de Vídeo na Placa-Mãe, e fixe com os respectivos parafusos pela parte traseira do gabinete.

PAINEL I/O

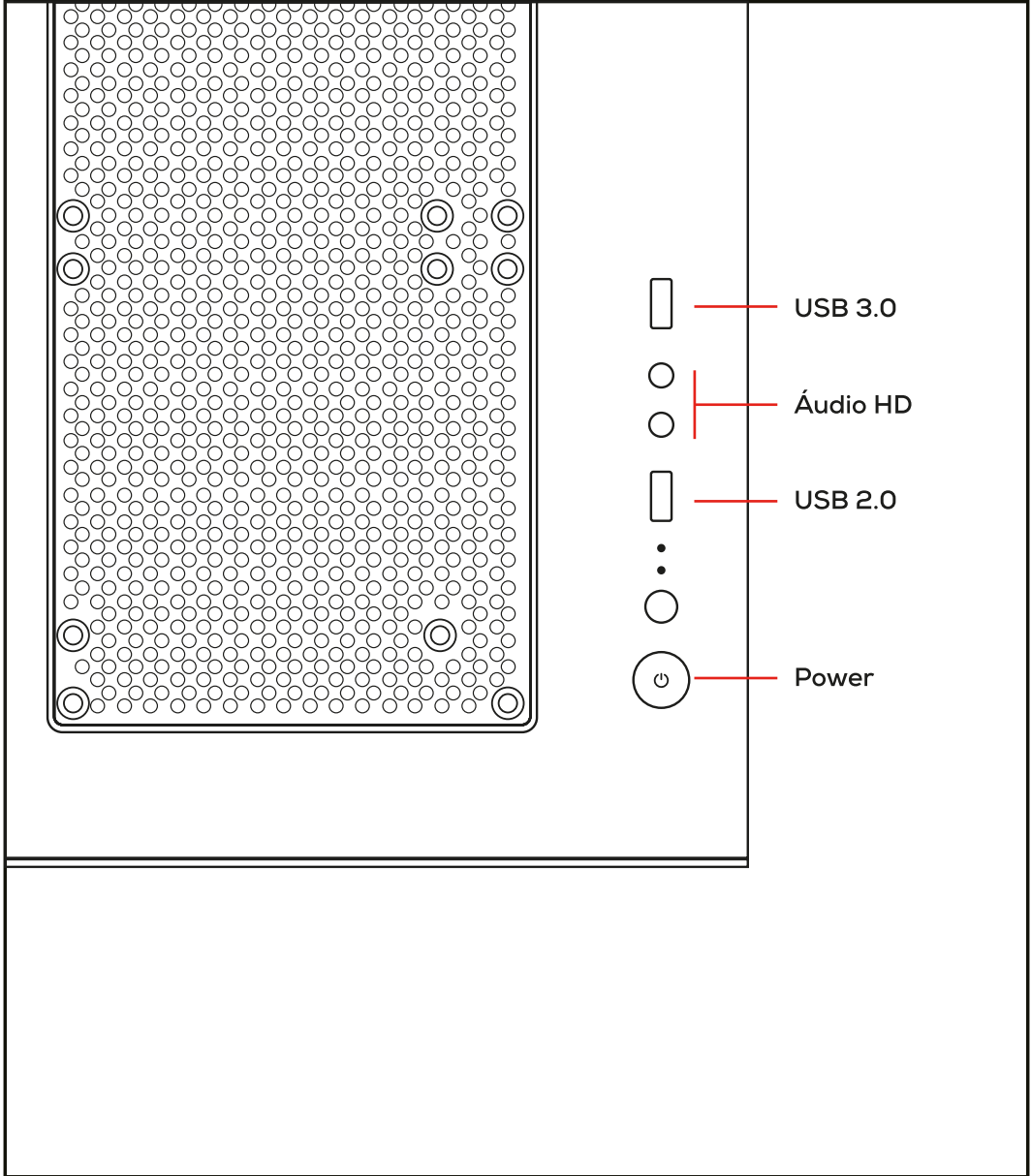

CONECTORES

Conector de Áudio HD do Gabinete



Conector de Áudio HD da Placa-Mãe

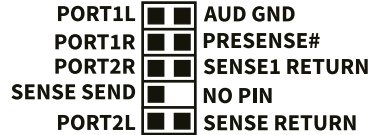

Conector USB 2.0 do Gabinete

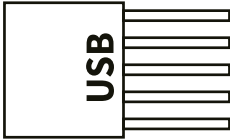

Conector USB 2.0 da Placa-Mãe

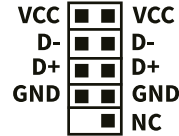

Conector USB 3.0 do Gabinete

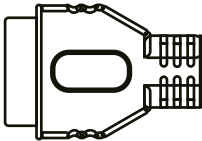

Conector USB 3.0 da Placa-Mãe

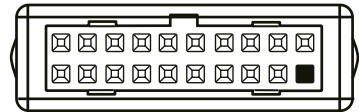

Conector Power/Reset/LED do Gabinete

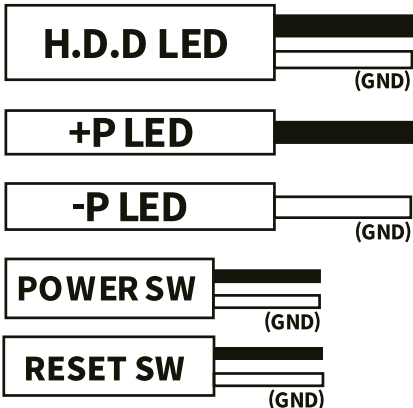

Conector Power/Reset/LED da Placa-Mãe

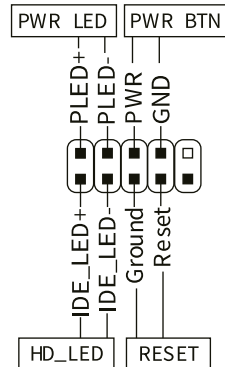

**AGRADECEMOS POR ESCOLHER O PICHAU GROUP
COMO PARTE DA SUA JORNADA.**

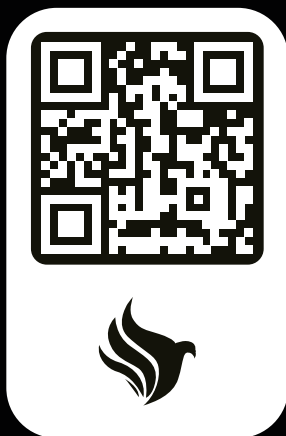

**EXPLORE NOSSOS SITES E ENCONTRE O
PRODUTO IDEAL PARA ELEVAR SUA EXPERIÊNCIA.**

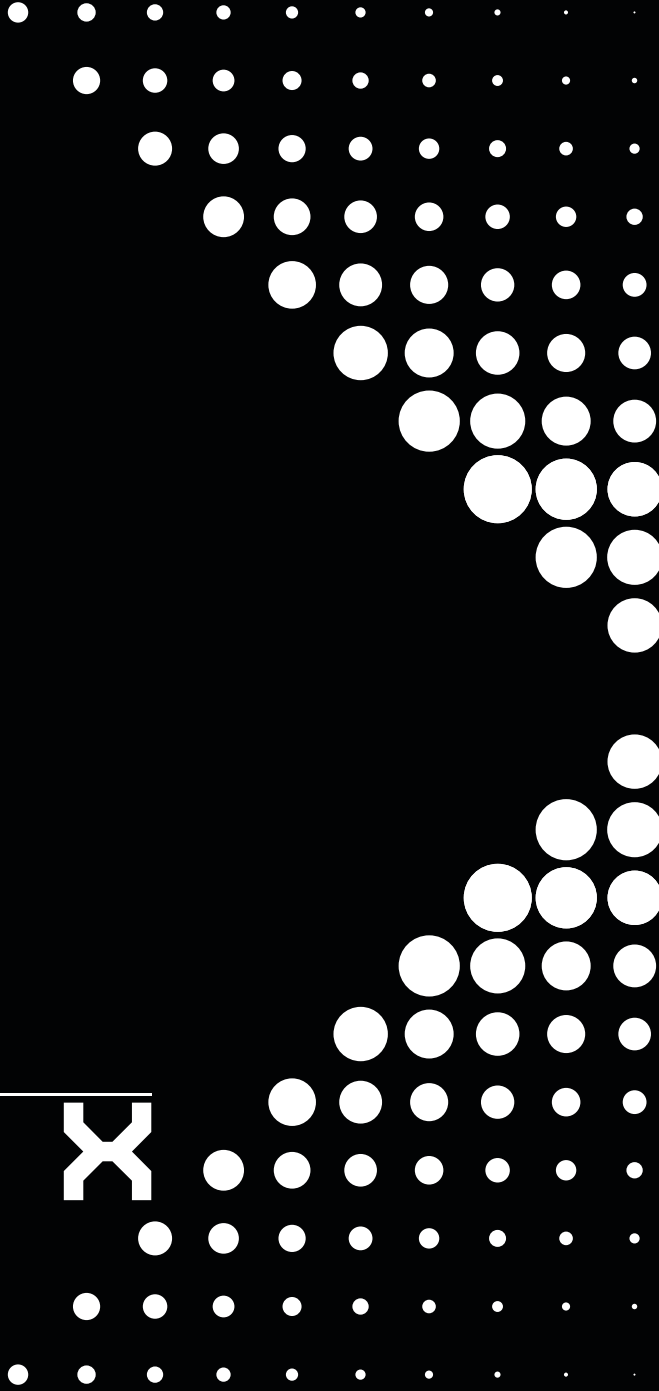

ESPAÑOL

ATOM X



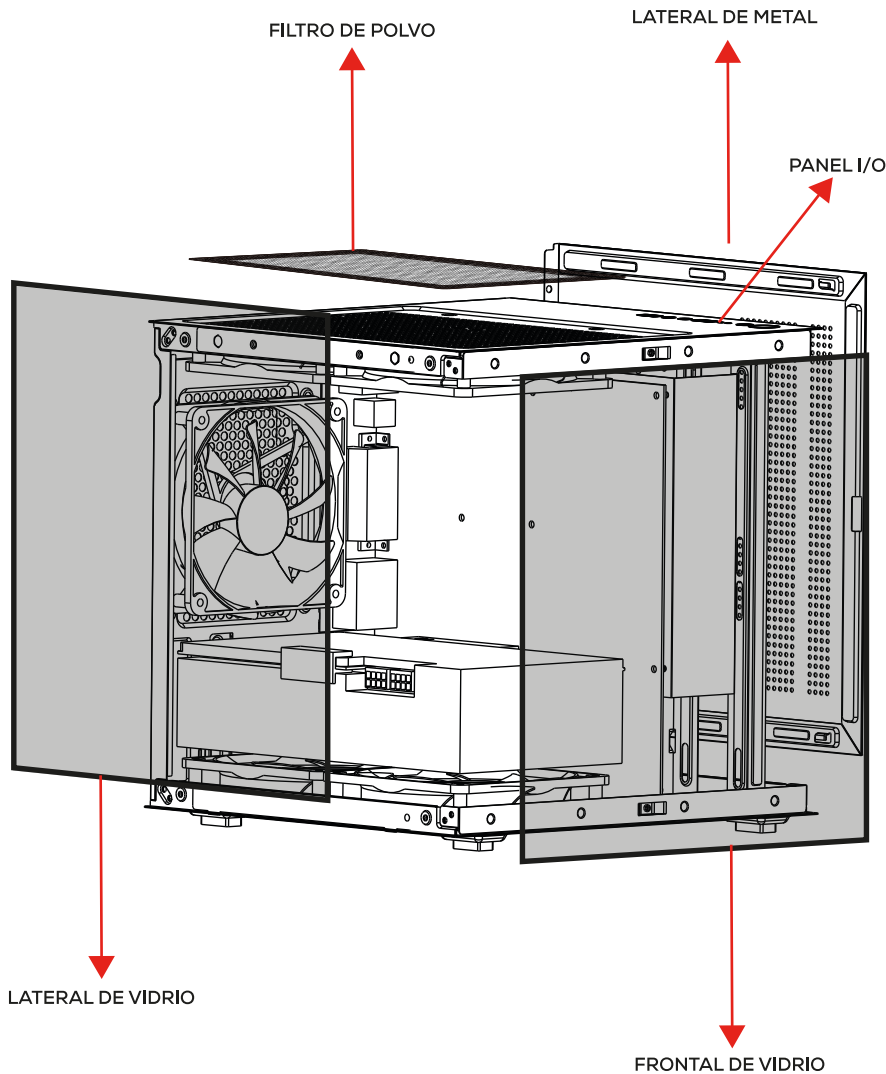

IMPORTANTE

ES DE EXTREMA IMPORTANCIA LEER, COMPRENDER Y SEGUIR TODAS LAS INSTRUCCIONES CONTENIDAS EN ESTE MANUAL. LAS FALLAS OCASIONADAS POR EL MANEJO INCORRECTO PUEDEN RESULTAR EN DAÑOS AL EQUIPO Y LA POSIBLE ANULACIÓN DE LA GARANTÍA.

COMPONENTES DEL HARDWARE



ACCESORIOS

Ítem	Nombre / Cant.	Utilidad
	Tornillos #6-32 6mm x5	Fuente de Alimentación y Tarjeta de Video
	Tornillos M3 5mm x11	Placa Madre y SSD 2.5"
	Tornillos #6-32 5mm x4	HDD 3.5"
	Separadores #6-32 6.5mm x2	Soporte para Placa Madre

APERTURA DEL GABINETE

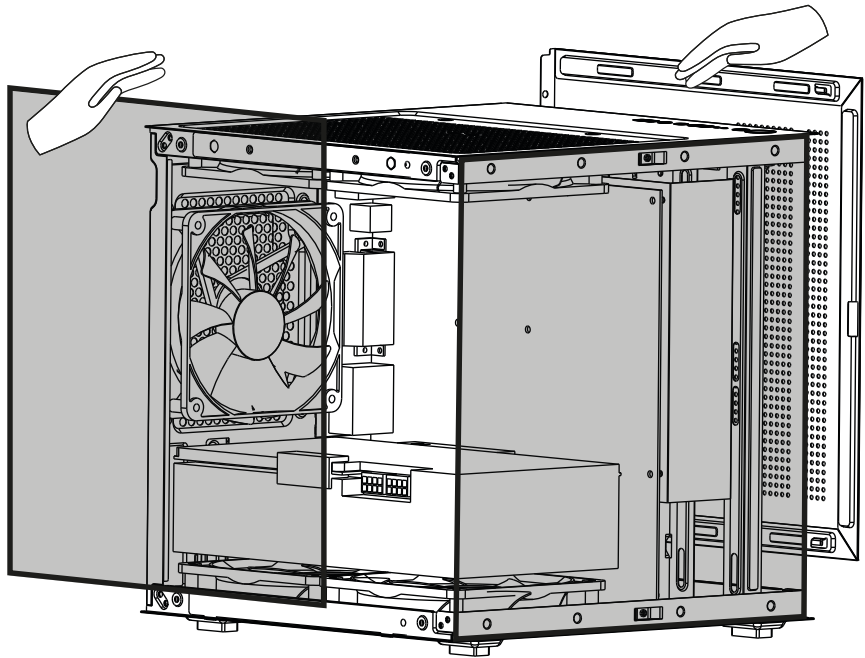

Desatornille y guarde los tornillos ubicados en la parte trasera o lateral del gabinete, luego retire los paneles laterales.

INSTALACIÓN DE LA PLACA MADRE

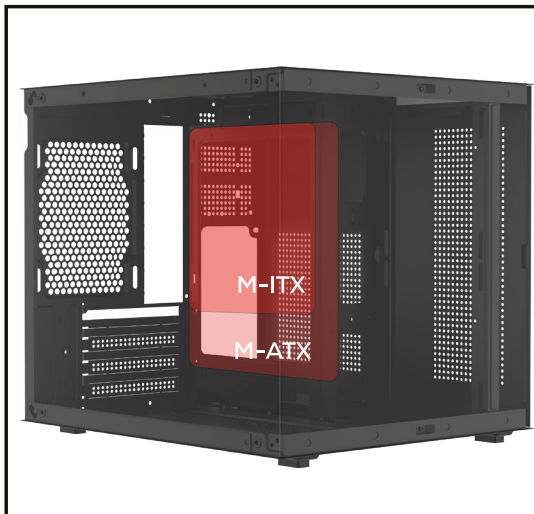

Posicione la Placa Madre alineando sus orificios con los del lugar de instalación, reposicione los separadores si es necesario y fíjela con los tornillos respectivos.

INSTALACIÓN DE HDD 3.5" Y SSD 2.5"

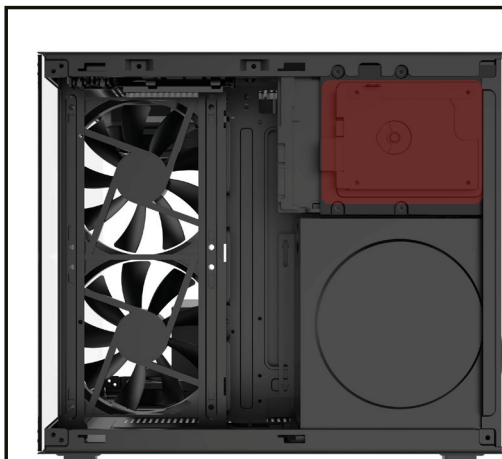

Posicione el HDD/SSD alineando sus orificios con los del lugar de instalación y fíjelo con los tornillos respectivos.

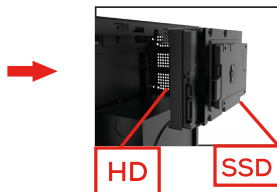

INSTALACIÓN DE LOS VENTILADORES

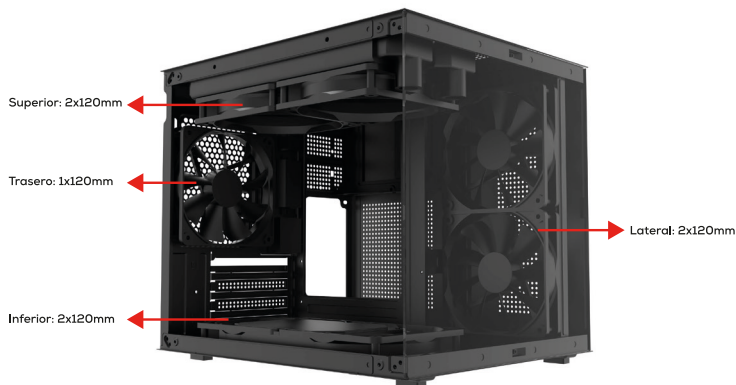

Posicione el Ventilador/Water Cooler alineando sus orificios con los del lugar de instalación, y fíjelo con los tornillos respectivos.

INSTALACIÓN DE LA FUENTE DE ALIMENTACIÓN

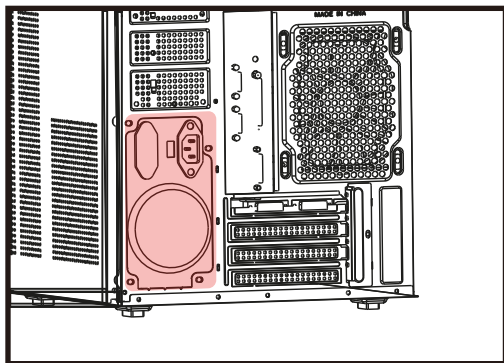

Retire el panel lateral de metal para tener acceso al lugar de instalación, posicione la Fuente de Alimentación alineando sus orificios con los del lugar de instalación, y fíjela con los tornillos respectivos por la parte trasera del gabinete.

INSTALACIÓN DE LA TARJETA DE VIDEO



Identifique y retire las cubiertas de los slots de expansión que utilizará el modelo de su Tarjeta de Video, conecte la placa a la Placa Madre y fijela con los tornillos respectivos por la parte trasera del gabinete.

PANEL I/O

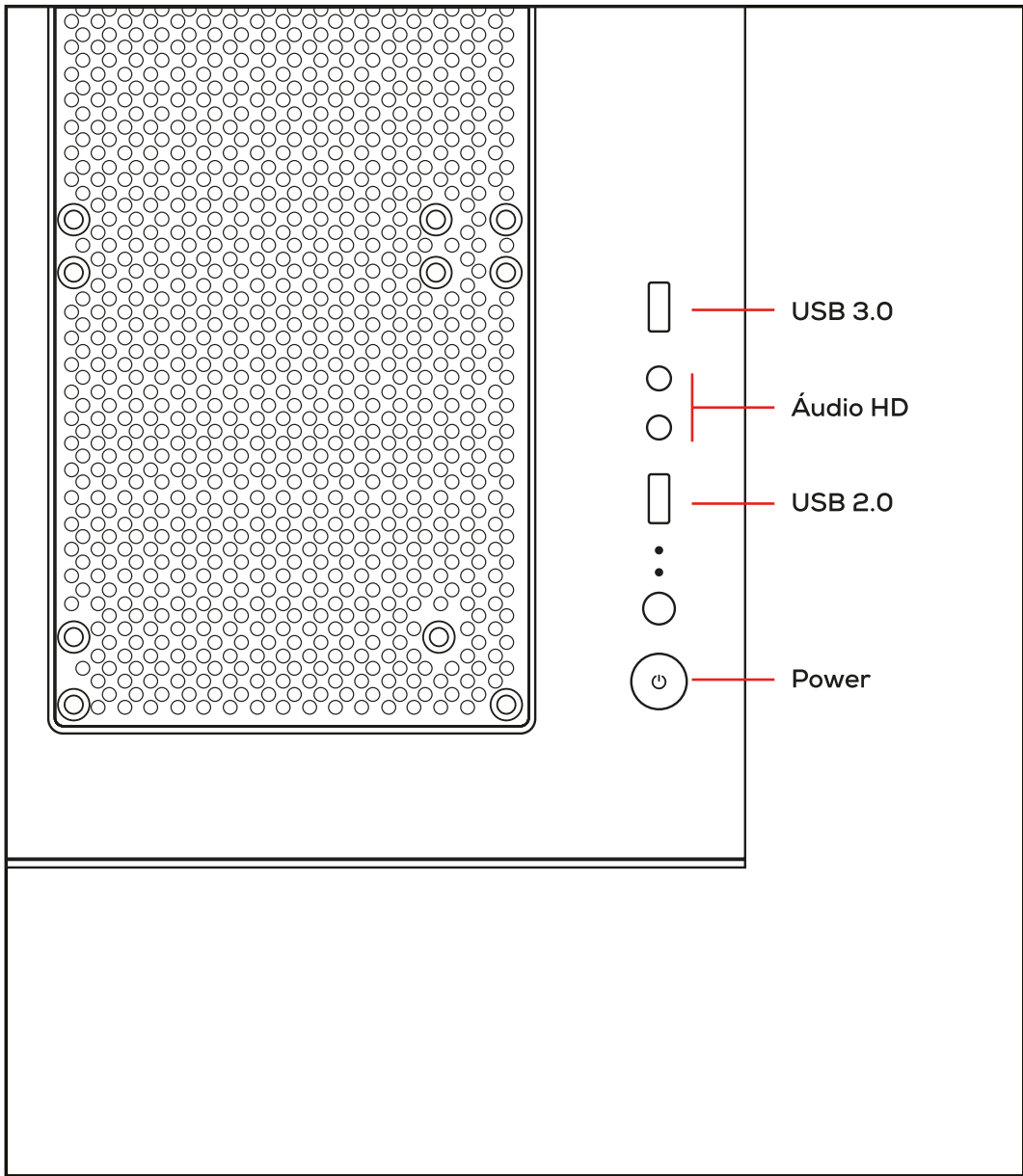

CONECTORES

Conector de Audio HD del Gabinete



Conector de Audio HD de la Placa Madre

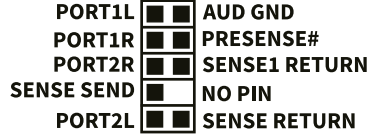

Conector USB 2.0 del Gabinete

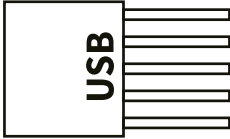

Conector USB 2.0 de la Placa Madre

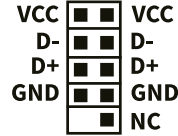

Conector USB 3.0 del Gabinete

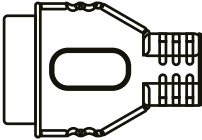

Conector USB 3.0 de la Placa Madre

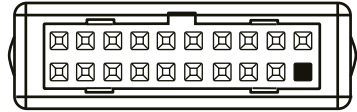

Conector Power/Reset/LED del Gabinete

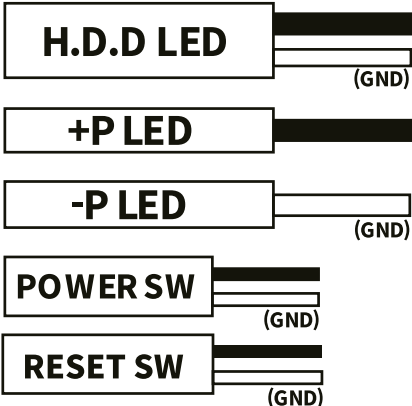

Conector Power/Reset/LED de la Placa Madre

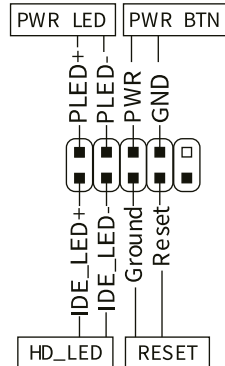

**GRACIAS POR ELEGIR A PICHAU GROUP
COMO PARTE DE SU TRAYECTORIA.**



**EXPLORE NUESTROS SITIOS Y ENCUENTRE EL
PRODUCTO IDEAL PARA ELEVAR SU EXPERIENCIA.**

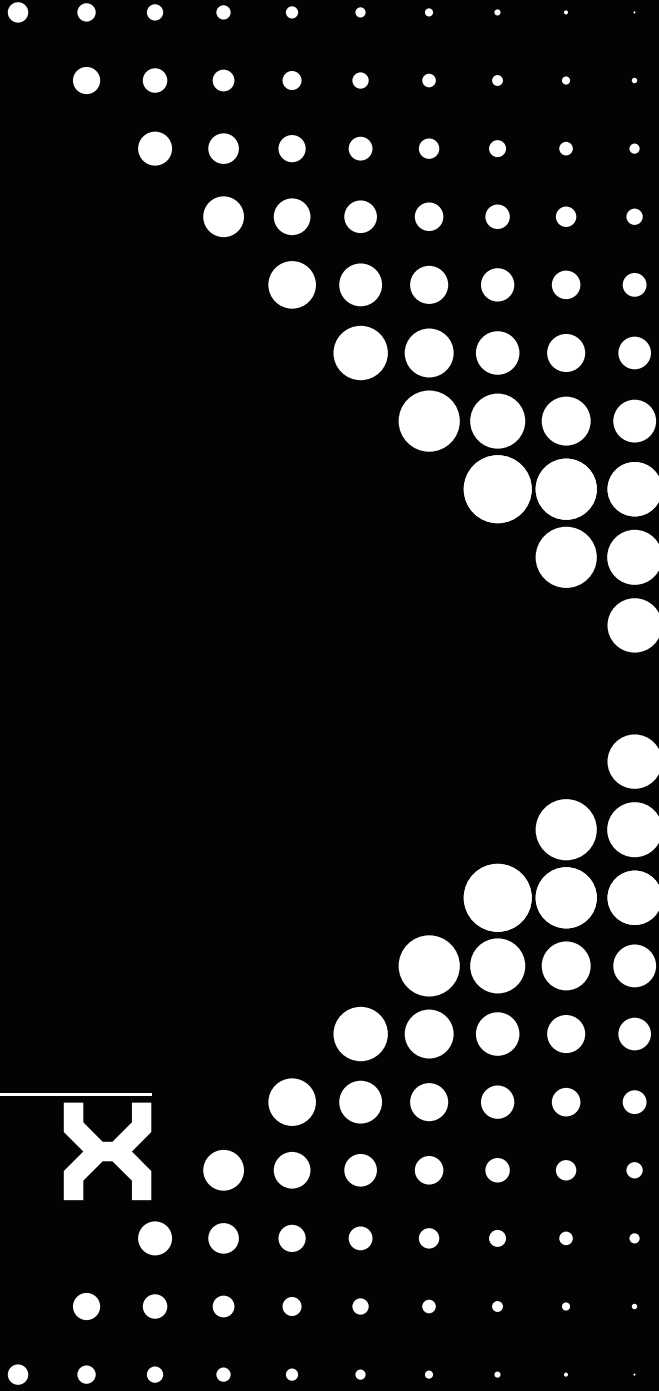

ENGLISH

ATOM X



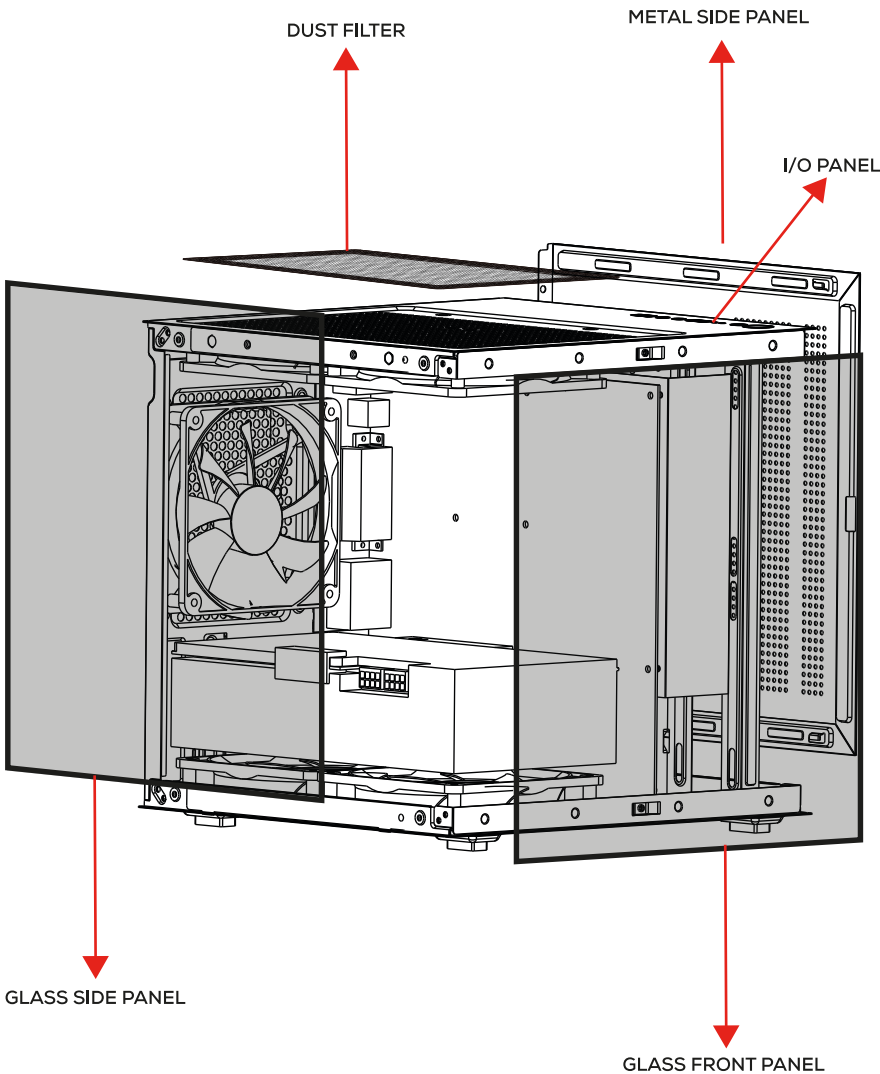

IMPORTANT

IT IS EXTREMELY IMPORTANT TO READ, UNDERSTAND, AND FOLLOW ALL INSTRUCTIONS CONTAINED IN THIS MANUAL. FAILURES CAUSED BY INCORRECT HANDLING MAY RESULT IN DAMAGE TO THE EQUIPMENT AND POSSIBLE VOIDING OF THE WARRANTY.

HARDWARE COMPONENTS



ACCESSORIES

Item	Name / Qty.	Utility / Usage
	Screws #6-32 6mm x5	Power Supply and Graphics Card
	Screws M3 5mm x11	Motherboard and 2.5" SSD
	Screws #6-32 5mm x4	3.5" HDD
	Standoffs #6-32 6.5mm x2	Motherboard Support

OPENING THE CASE

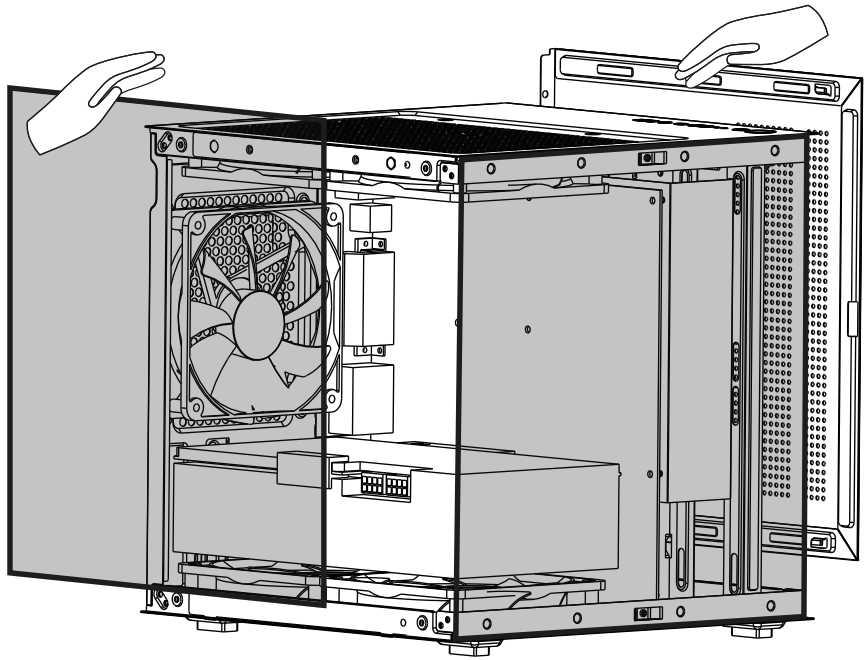

Unscrew and set aside the screws located on the rear or side of the case, then remove the side panels.

MOTHERBOARD INSTALLATION

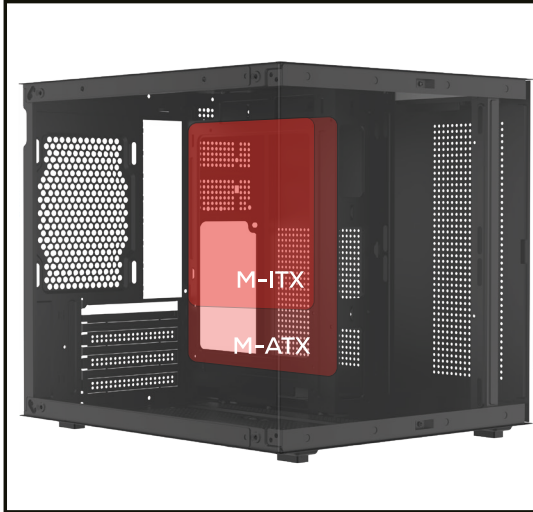

Position the Motherboard by aligning its mounting holes with those on the case, reposition the standoffs if necessary, and secure it with the corresponding screws.

3.5" HDD AND 2.5" SSD INSTALLATION

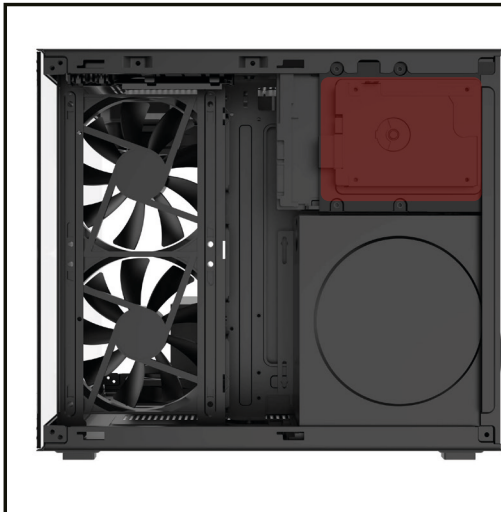

Position the HDD/SSD by aligning its mounting holes with those on the installation site, and secure it with the corresponding screws.

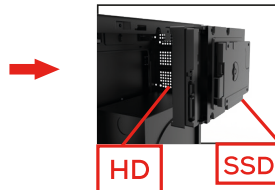

FAN INSTALLATION

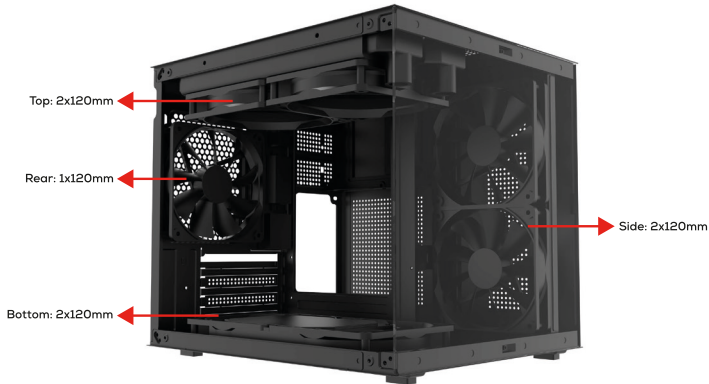

Position the Fan/AIO Liquid Cooler by aligning its mounting holes with those on the installation site, and secure it with the corresponding screws.

POWER SUPPLY INSTALLATION (PSU)

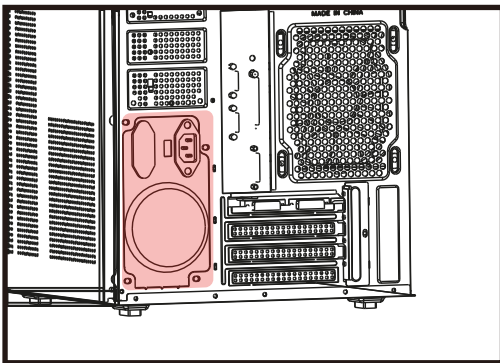

Remove the metal side panel to access the installation area, position the Power Supply by aligning its mounting holes with those on the case, and secure it with the corresponding screws from the rear of the case.

GRAPHICS CARD INSTALLATION



Identify and remove the expansion slot covers that your Graphics Card model will use, connect the card to the Motherboard, and secure it with the corresponding screws from the rear of the case.

I/O PANEL

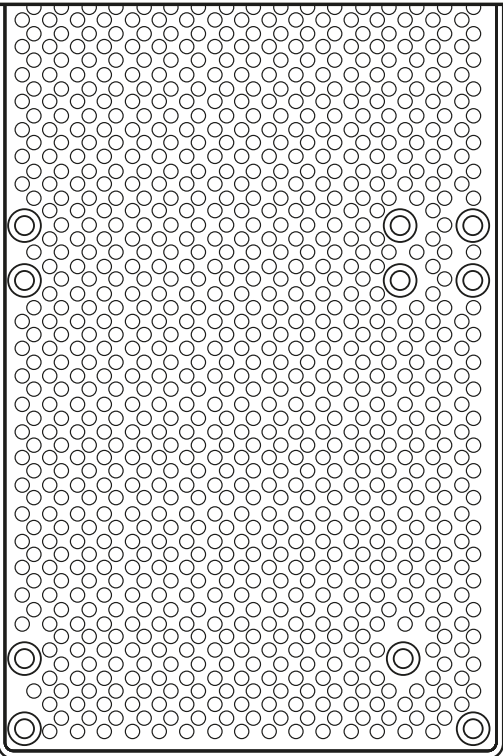

USB 3.0



Áudio HD



USB 2.0



Power

CONNECTORS

Case HD Audio Connector



Motherboard HD Audio Connector

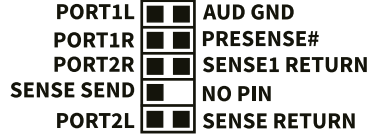

Case USB 2.0 Connector

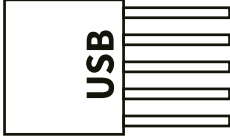

Motherboard USB 2.0 Connector

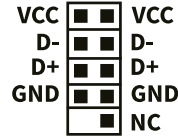

Case USB 3.0 Connector

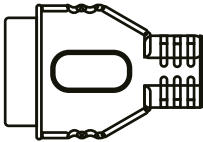

Motherboard USB 3.0 Connector

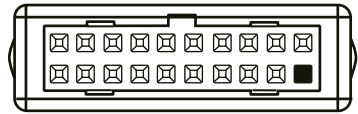

Case Power/Reset/LED Connector

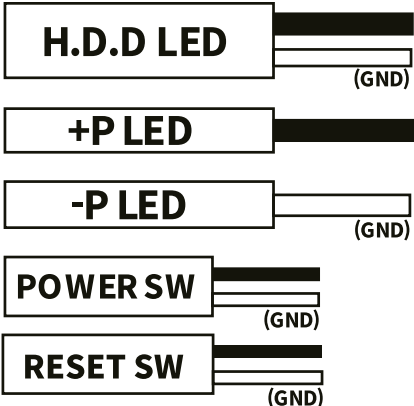

Motherboard Power/Reset/LED Connector

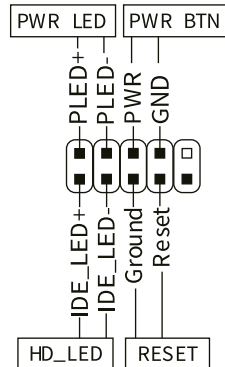

**THANK YOU FOR CHOOSING PICHAU GROUP
AS PART OF YOUR JOURNEY.**

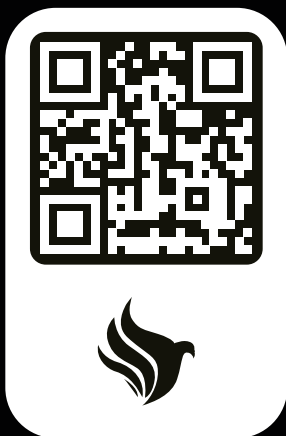

**EXPLORE OUR WEBSITES AND FIND THE
IDEAL PRODUCT TO ELEVATE YOUR EXPERIENCE.**

