



MANUAL

---

**HX110**

# **IMPORTANTE**

**É DE EXTREMA IMPORTÂNCIA LER, COMPREENDER E SEGUIR TODAS AS INSTRUÇÕES CONTIDAS NESTE MANUAL. O MANUSEIO INCORRETO PODE DANIFICAR O EQUIPAMENTO E OCASIONAR A ANULAÇÃO DA GARANTIA.**

# COMPONENTES DO HARDWARE

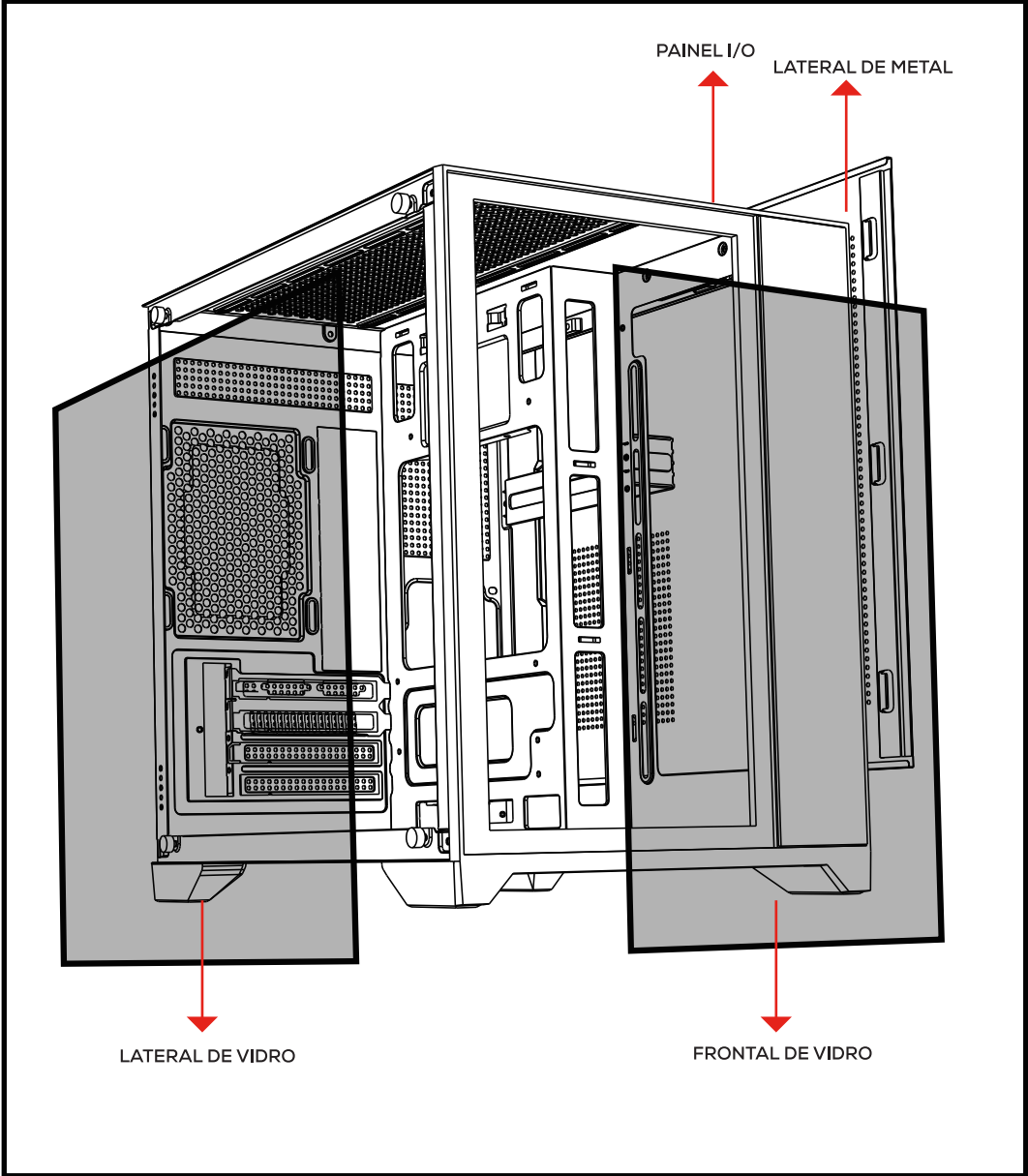

# ACESSÓRIOS

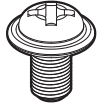
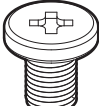
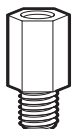
Item	Nome/Quant.	Utilidade
	Parafusos #6-32 6mm x5	Fonte de Alimentação e Placa de Vídeo
	Parafusos M3 5mm x10	Placa-Mãe e SSD 2.5"
	Parafusos #6-32 5mm x4	HDD 3.5"
	Espaçadores #6-32 6.5mm x2	Suporte para Placa-Mãe

# ABERTURA DO GABINETE

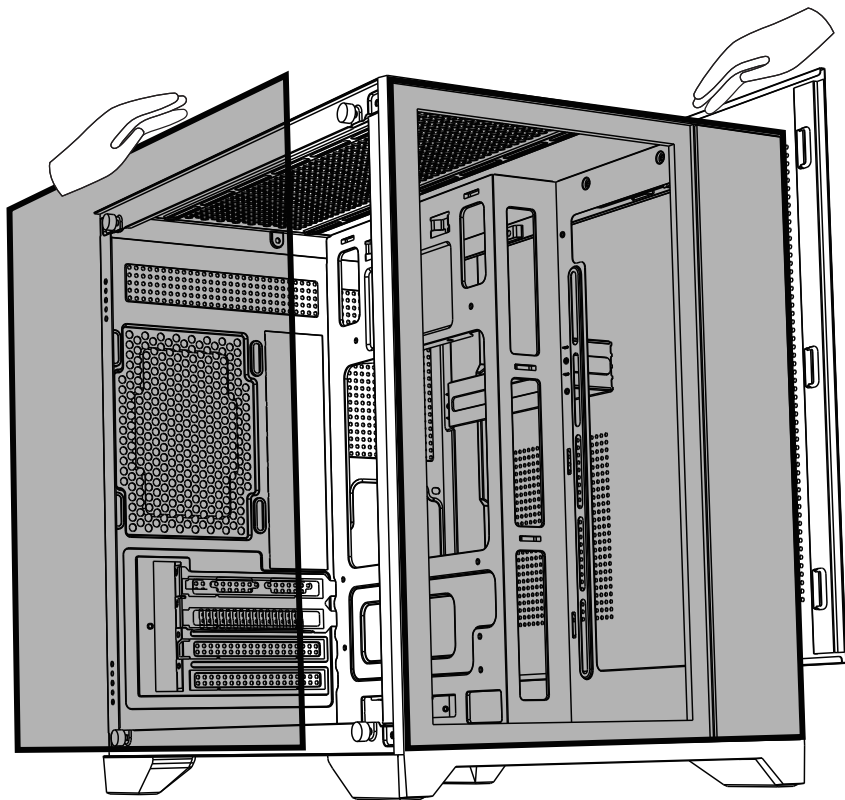

Desparafuse e reserve os parafusos localizados na parte traseira do gabinete, então remova as laterais.

## INSTALAÇÃO DA PLACA-MÃE

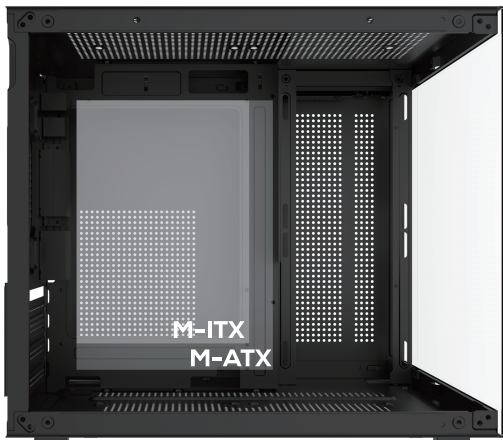

Posicione a Placa-Mãe alinhando suas furações com as do local de instalação, reposicione os espaçadores se necessário, e fixe com os respectivos parafusos.

## INSTALAÇÃO DE HDD 3.5" E SSD 2.5"



Posicione o HDD/SSD alinhando suas furações com as do local de instalação, e fixe com os respectivos parafusos.

# INSTALAÇÃO DAS VENTOINHAS

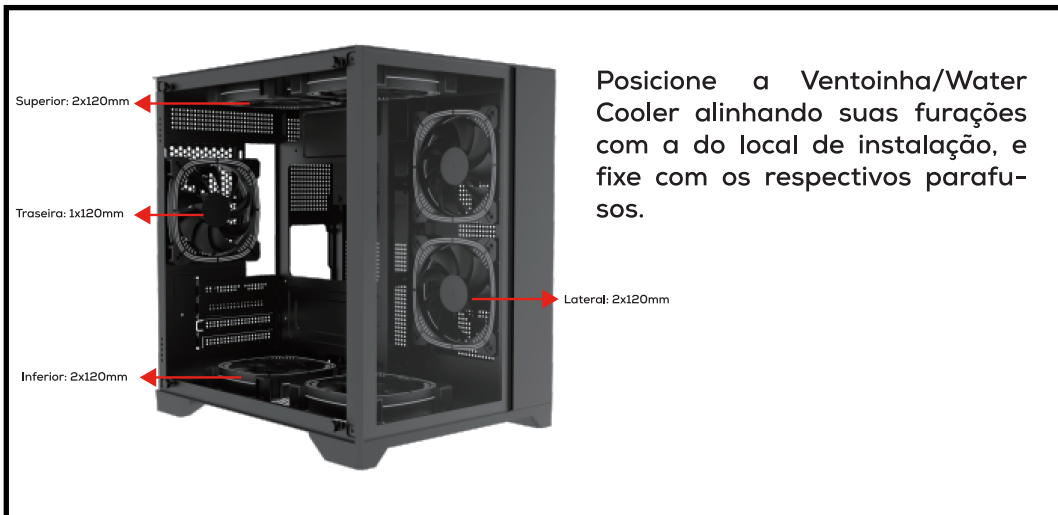

# INSTALAÇÃO DA FONTE DE ALIMENTAÇÃO

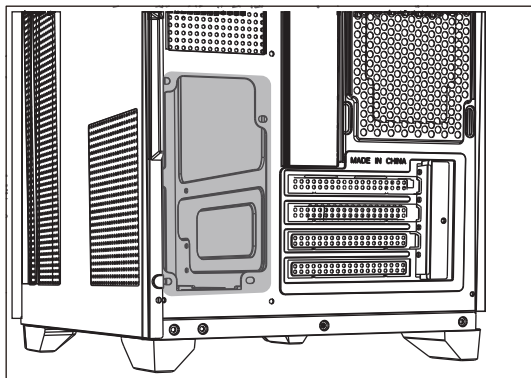

Remova a lateral de metal para ter acesso ao local de instalação, posicione a Fonte de Alimentação alinhando suas furações com o local de instalação, e fixe com os respectivos parafusos pela parte traseira do gabinete.

# INSTALAÇÃO DA PLACA DE VÍDEO

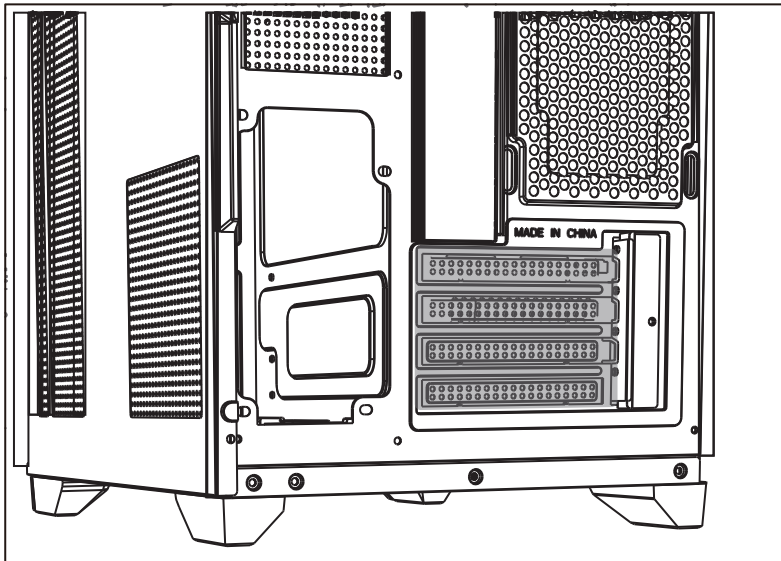

Posicione a Placa de vídeo alinhando suas furações com as do local de instalação, reposicione os espaçadores se necessário, e fixe com os respectivos parafusos.

# PAINEL I/O

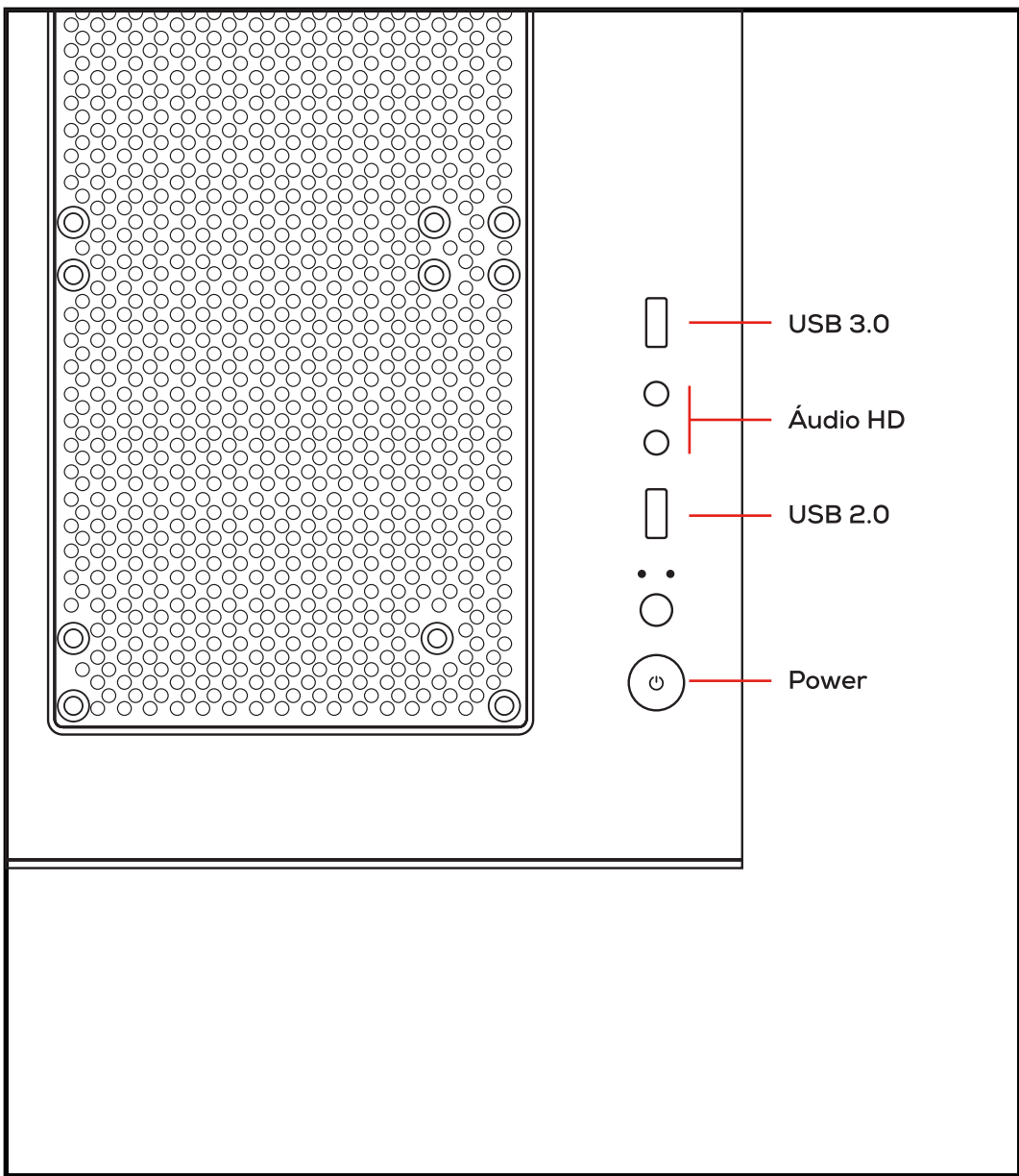



**AGRADECEMOS POR ESCOLHER O PICHAU GROUP  
COMO PARTE DA SUA JORNADA.**

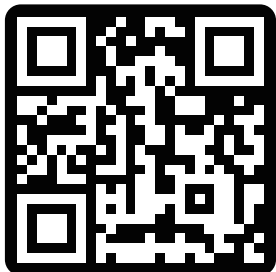

**PICHAU**

**EXPLORE NOSSOS SITES E ENCONTRE O  
PRODUTO IDEAL PARA ELEVAR SUA EXPERIÊNCIA.**



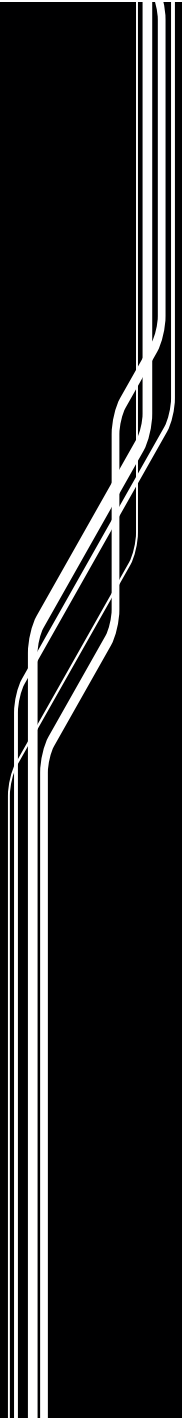

MANUAL | ESPAÑOL

**HX110**



# **IMPORTANTE**

**ES DE EXTREMA IMPORTANCIA LEER, COMPRENDER Y SEGUIR TODAS LAS INSTRUCCIONES EN ESTE MANUAL. UN MANEJO INCORRECTO PUEDE DAÑAR EL EQUIPO Y DAR LUGAR A LA ANULACIÓN DE LA GARANTÍA.**

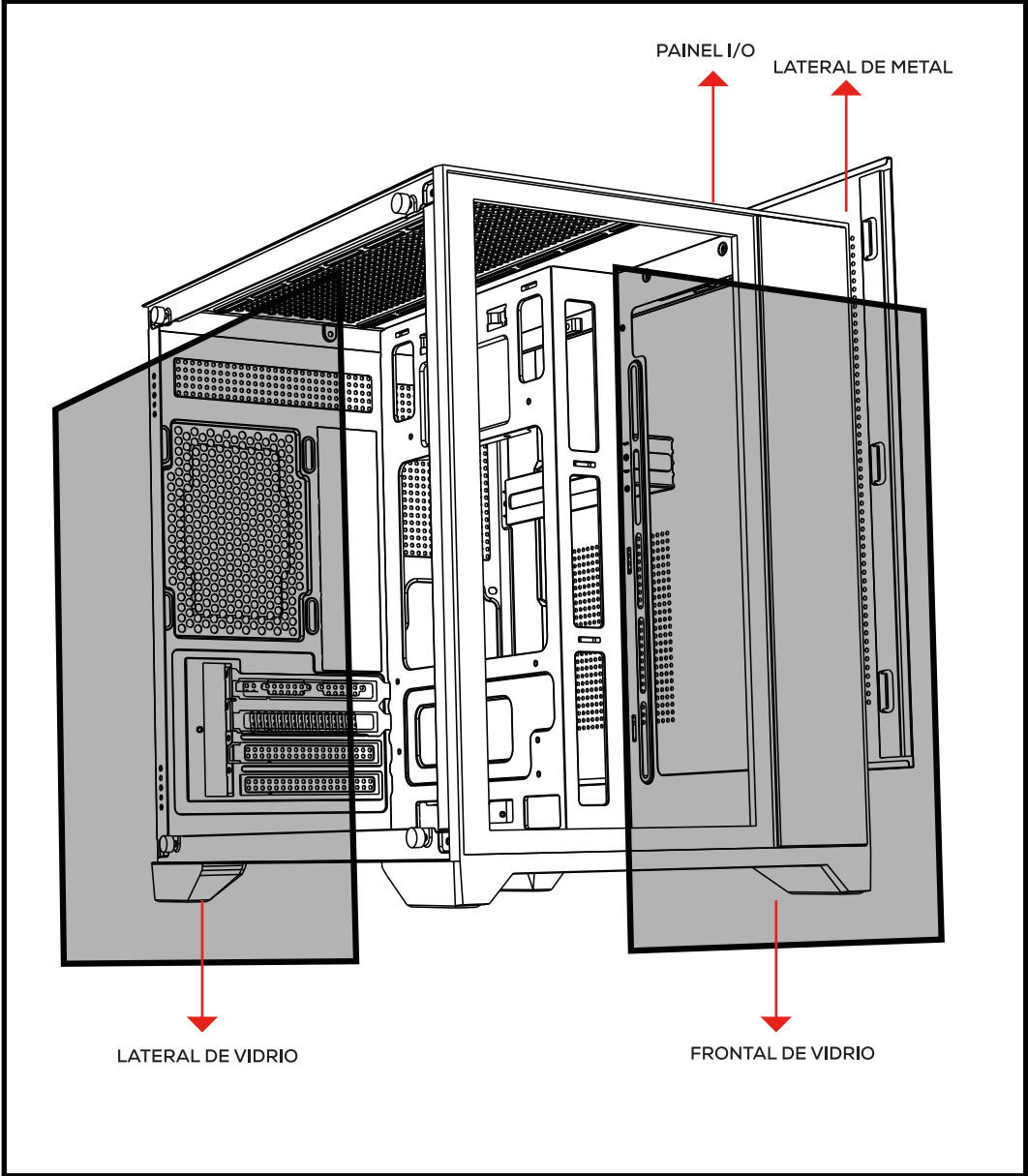
# COMPONENTES DEL HARDWARE

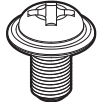

# ACESSÓRIOS

Item	Nombre / Cant.	Utilidad
	Tornillos #6-32 6mm x5	Fuente de Alimentación y Tarjeta de Video
	Tornillos M3 5mm x10	Placa Madre y SSD 2.5"
	Tornillos #6-32 5mm x4	HDD 3.5"
	Separadores #6-32 6.5mm x2	Soporte para Placa Madre

# APERTURA DEL GABINETE

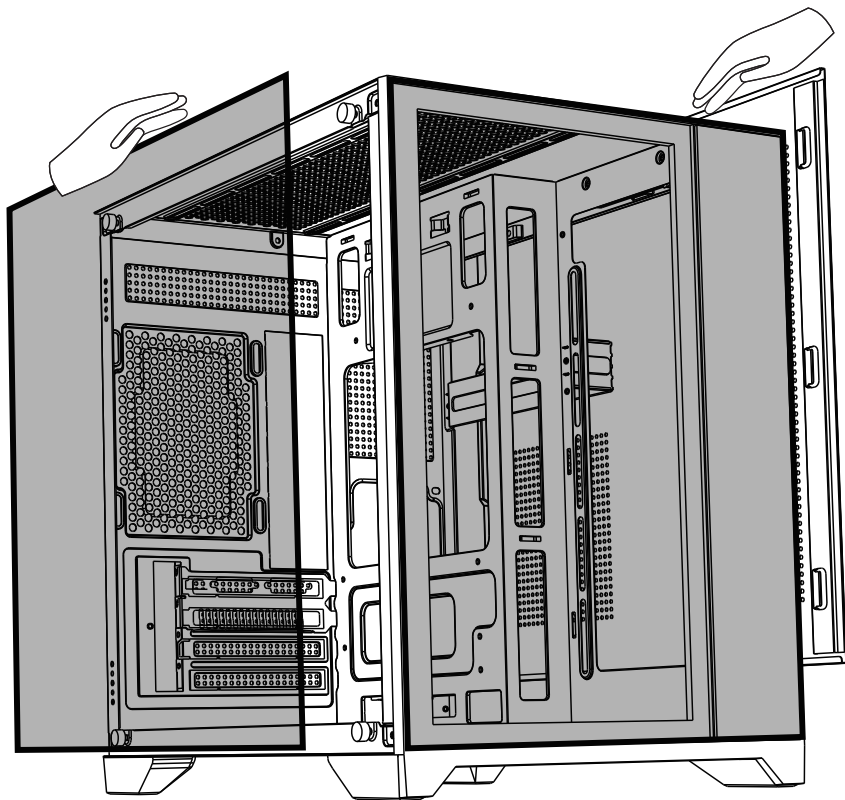

Desatornille y guarde los tornillos ubicados en la parte trasera o lateral del gabinete, luego retire los paneles laterales.

## INSTALACIÓN DE LA PLACA MADRE

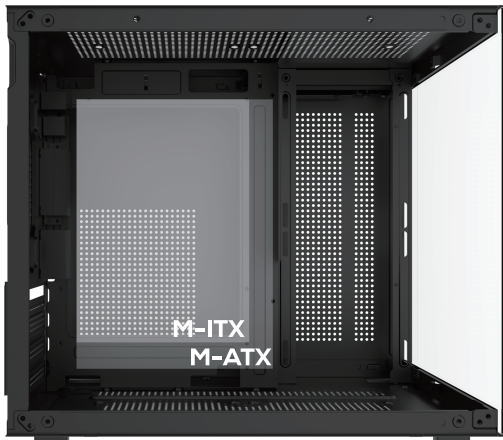

Posicione la Placa Madre alineando sus orificios con los del lugar de instalación, reposicione los separadores si es necesario y fíjela con los tornillos respectivos.

## INSTALACIÓN DE HDD 3.5" Y SSD 2.5"



Posicione el HDD/SSD alineando sus orificios con los del lugar de instalación y fíjelo con los tornillos respectivos.

# INSTALACIÓN DE LOS VENTILADORES

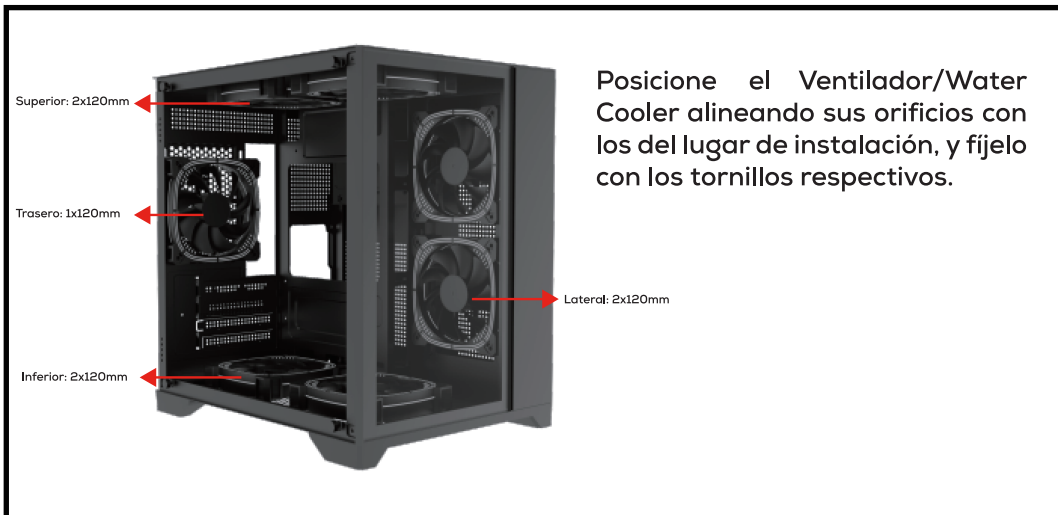

# INSTALACIÓN DE LA FUENTE DE ALIMENTACIÓN

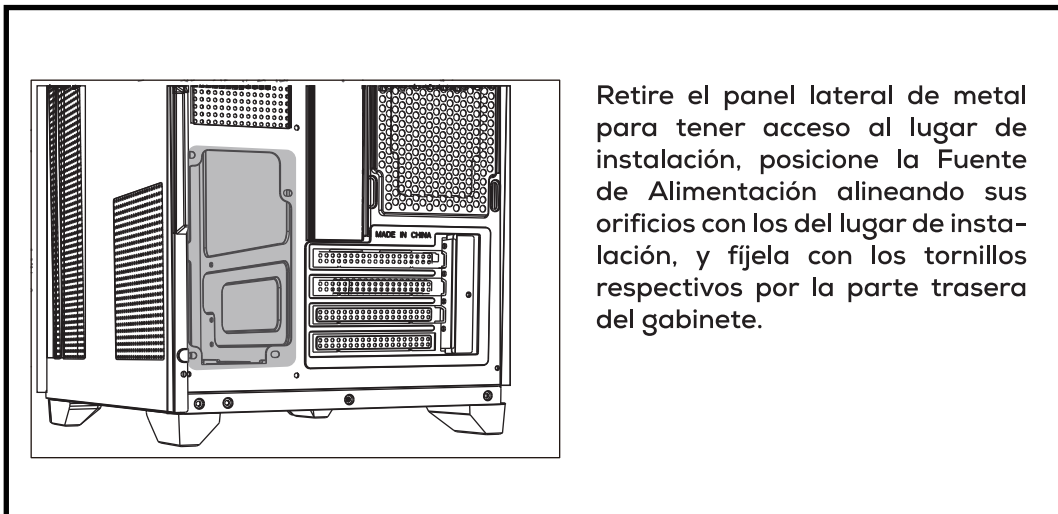

# INSTALACIÓN DE LA TARJETA DE VIDEO

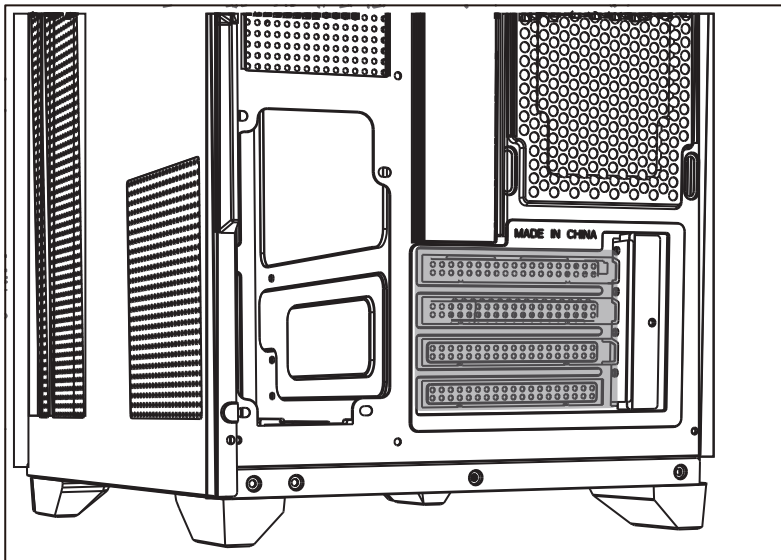

Posicione la Tarjeta de Video alineando sus conectores con el slot de la Placa Madre, asegúrese de que encaje correctamente y fijela con los tornillos respectivos en el panel trasero.

# PANEL I/O

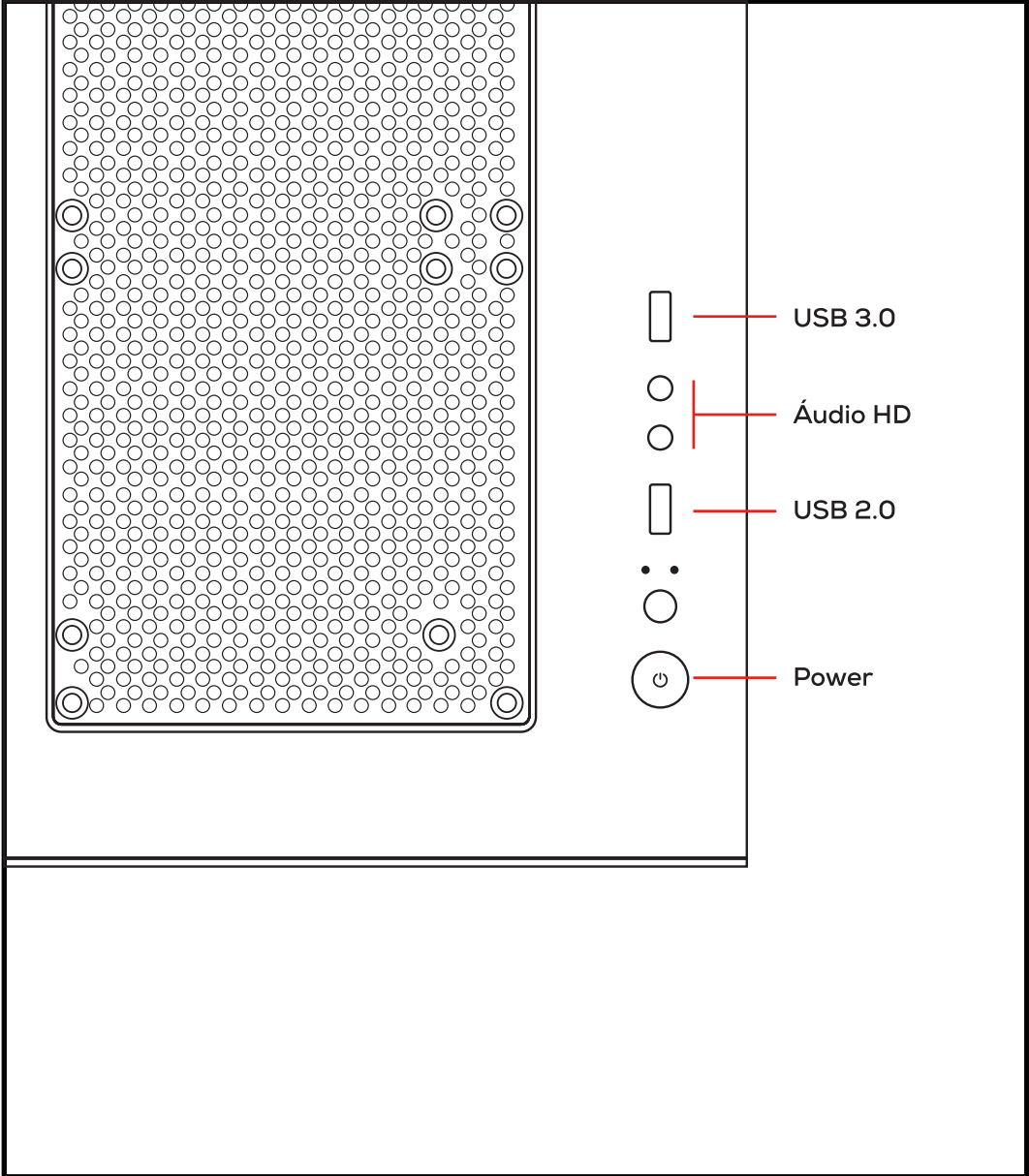



**LE AGRADECEMOS QUE HAYA ELEGIDO A PICHAU GROUP  
COMO PARTE DE SU TRAYECTORIA.**



**EXPLORA NUESTRAS PÁGINAS WEB Y ENCUENTRA EL  
PRODUCTO IDEAL PARA MEJORAR TU EXPERIENCIA.**



MANUAL | ENGLISH

---

**HX110**

# **IMPORTANT**

**IT IS EXTREMELY IMPORTANT TO READ, UNDERSTAND, AND FOLLOW ALL THE INSTRUCTIONS IN THIS MANUAL. INCORRECT HANDLING MAY DAMAGE THE EQUIPMENT AND VOID THE WARRANTY.**

# HARDWARE COMPONENTS

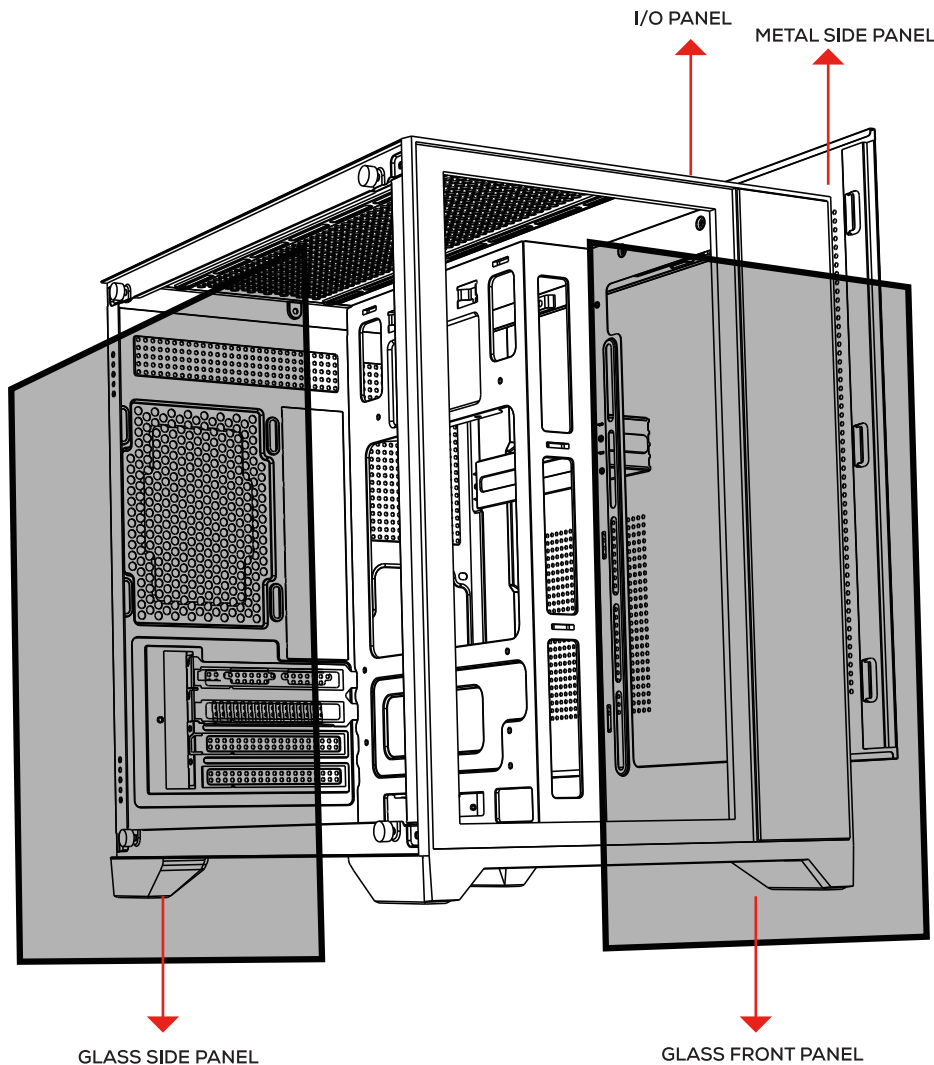

# ACCESSORIES

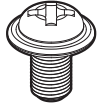
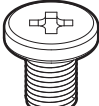
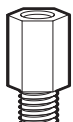
Item	Name / Qty.	Utility / Usage
	Screws #6-32 6mm x5	Power Supply and Graphics Card
	Screws M3 5mm x10	Motherboard and 2.5" SSD
	Screws #6-32 5mm x4	3.5" HDD
	Standoffs #6-32 6.5mm x2	Motherboard Support

# OPENING THE CASE

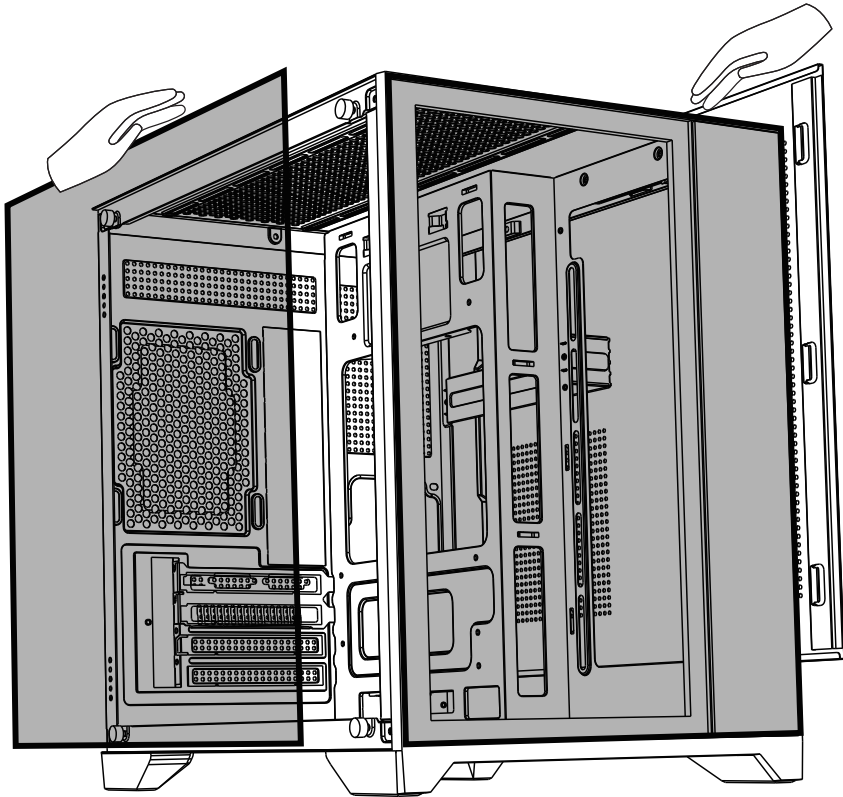

Unscrew and set aside the screws located on the rear or side of the case, then remove the side panels.

# MOTHERBOARD INSTALLATION

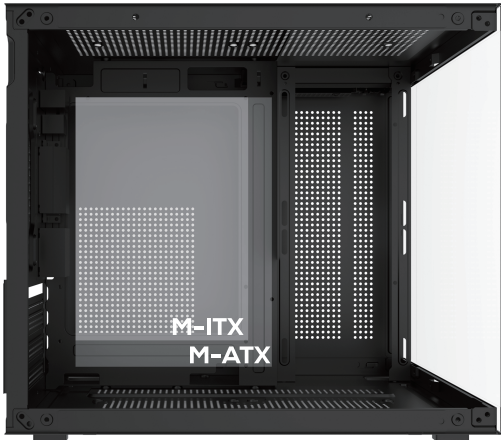

Position the Motherboard by aligning its mounting holes with those on the case, reposition the standoffs if necessary, and secure it with the corresponding screws.

# 3.5" HDD AND 2.5" SSD INSTALLATION



Position the HDD/SSD by aligning its mounting holes with those on the installation site, and secure it with the corresponding screws.

# FAN INSTALLATION

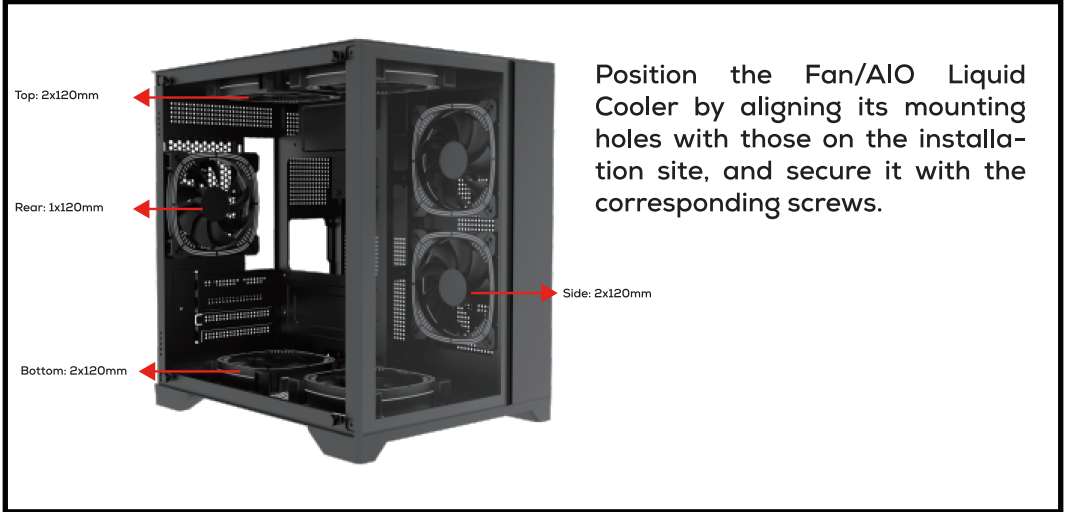

# POWER SUPPLY INSTALLATION (PSU)

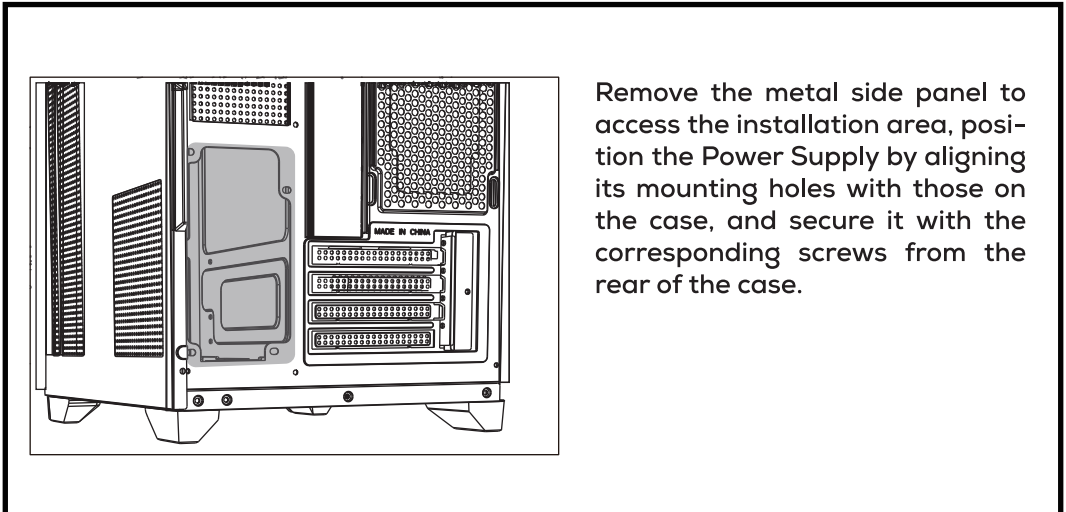

# GRAPHICS CARD INSTALLATION

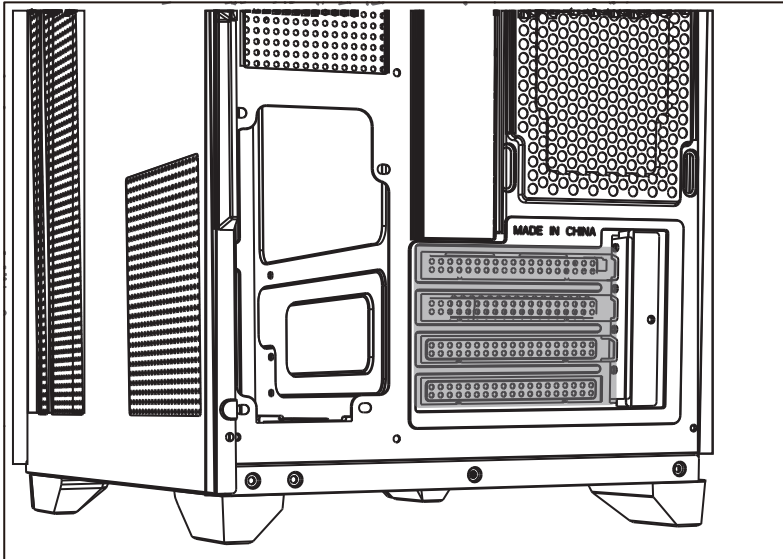

Position the Graphics Card by aligning its connectors with the Motherboard slot, ensure it is properly seated, and secure it with the corresponding screws on the rear panel.

# I/O PANEL

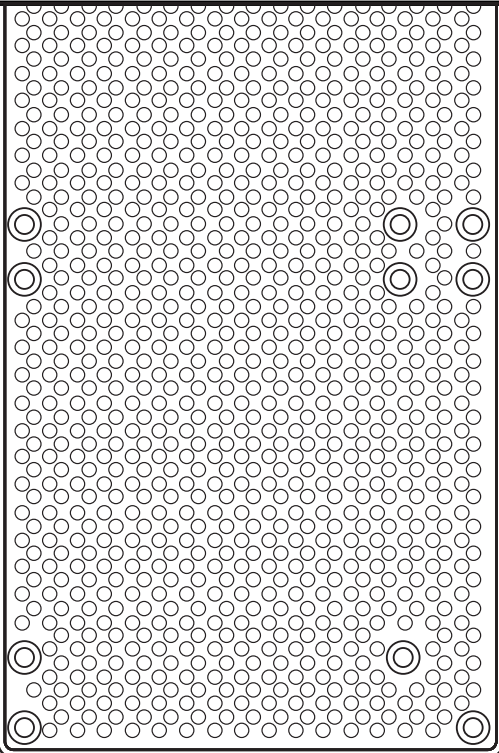

USB 3.0



Áudio HD



USB 2.0



Power

# CONNECTORS

## Case HD Audio Connector

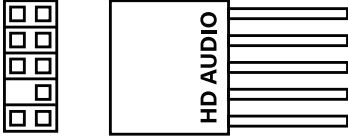

## Motherboard HD Audio Connector

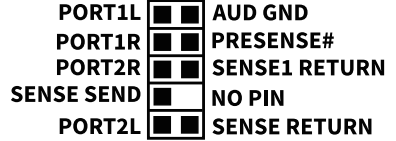

## Case USB 2.0 Connector

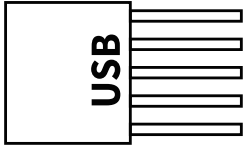

## Motherboard USB 2.0 Connector

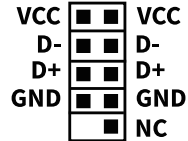

## Case USB 3.0 Connector

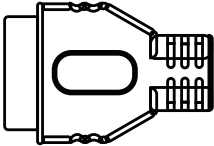

## Motherboard USB 3.0 Connector

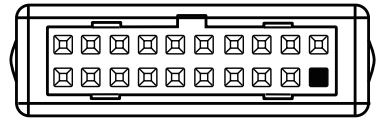

## Case Power/Reset/LED Connector

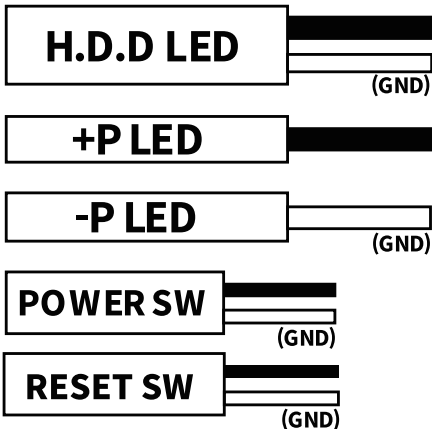

## Motherboard Power/Reset/LED Connector

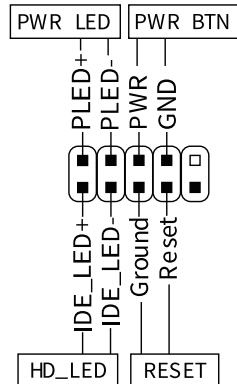

**THANK YOU FOR CHOOSING THE PICHAU GROUP  
AS PART OF YOUR JOURNEY.**



**PICHAU**

**EXPLORE OUR WEBSITES AND FIND THE  
PERFECT PRODUCT TO ENHANCE YOUR EXPERIENCE.**