



MANUAL

---

**MAGPIE 4B**



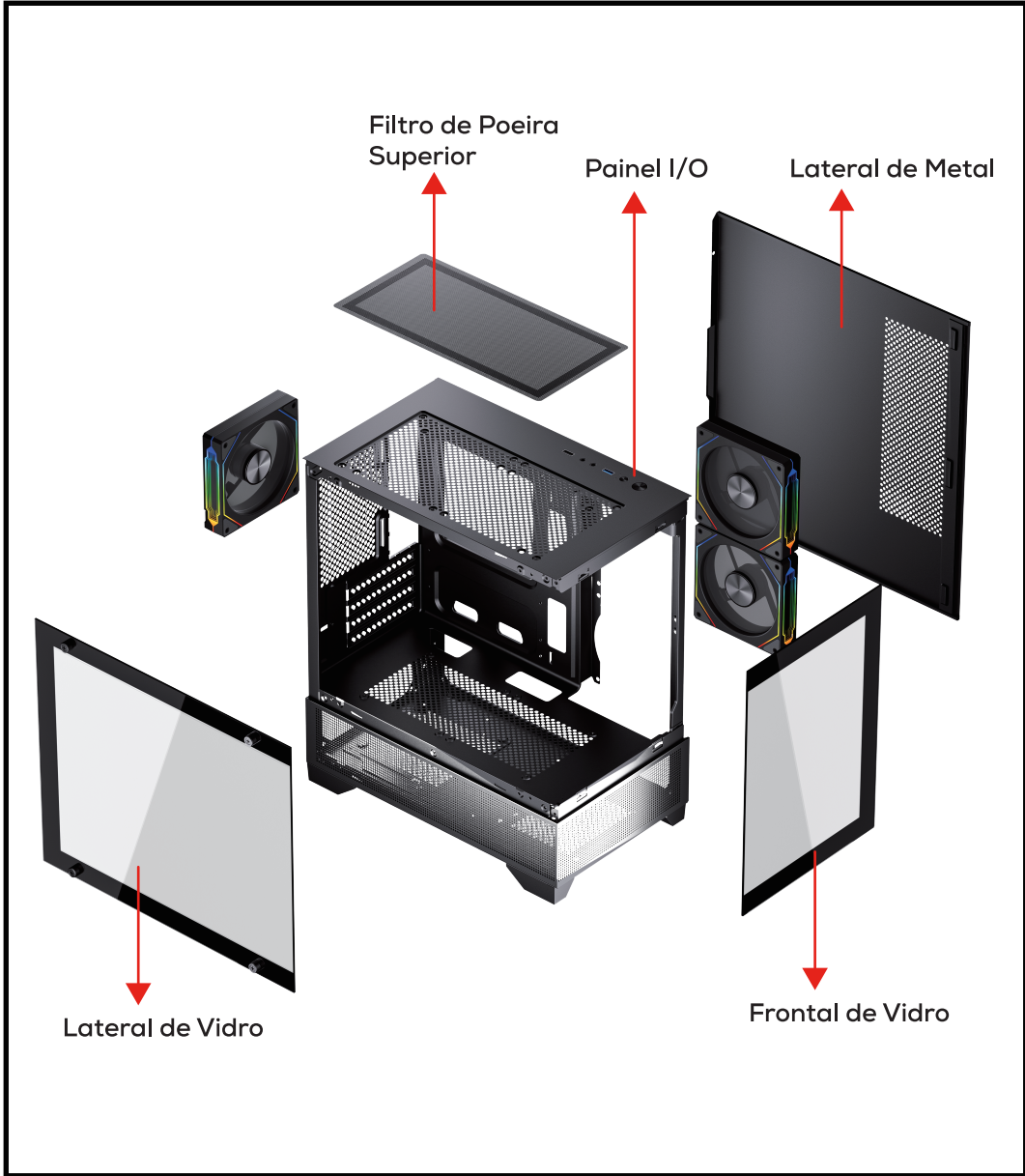

# **IMPORTANTE**

**É DE EXTREMA IMPORTÂNCIA LER, COMPREENDER E SEGUIR TODAS AS INSTRUÇÕES CONTIDAS NESTE MANUAL. O MANUSEIO INCORRETO PODE DANIFICAR O EQUIPAMENTO E OCASIONAR A ANULAÇÃO DA GARANTIA.**

# COMPONENTES DO HARDWARE



# ACESSÓRIOS

Item	Nome/Quant.	Utilidade
	Parafusos #6-32 6mm x5	Fonte de Alimentação e Placa de Vídeo
	Parafusos M3 5mm x10	Placa-Mãe e SSD 2.5"
	Parafusos #6-32 5mm x4	HDD 3.5"
	Espaçadores #6-32 6.5mm x2	Suporte para Placa-Mãe
	Parafusos M3 28mm x8	Parafuso das Ventoinhas

# ABERTURA DO GABINETE

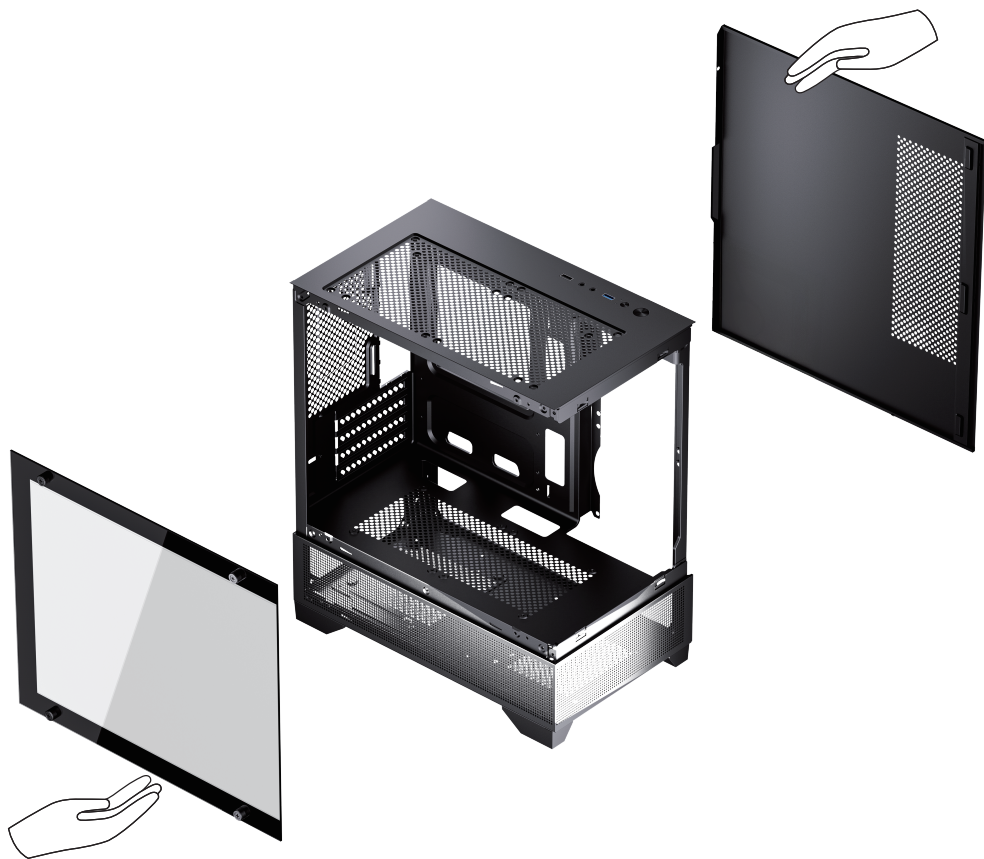

Desparafuse e reserve os parafusos localizados na parte traseira do gabinete, remova primeiro as laterais para então remover a parte superior e a frontal

## INSTALAÇÃO DA PLACA-MÃE

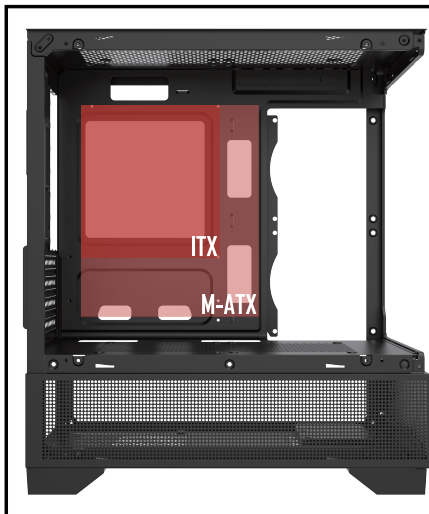

Posicione a Placa-Mãe alinhando suas furações com as do local de instalação, reposicione os espaçadores se necessário, e fixe com os respectivos parafusos.

## INSTALAÇÃO DE HDD 3.5" E SSD 2.5"



Posicione o HDD/SSD alinhando suas furações com as do local de instalação, e fixe com os respectivos parafusos.

## INSTALAÇÃO DAS VENTONHAS



## INSTALAÇÃO DA FONTE DE ALIMENTAÇÃO



# INSTALAÇÃO DA PLACA DE VÍDEO



Identifique e remova os slots de expansão que o modelo da Placa de Vídeo irá utilizar, conecte a Placa de Vídeo na Placa-Mãe, e fixe com os respectivos parafusos pela parte traseira do gabinete.

# PAINEL I/O

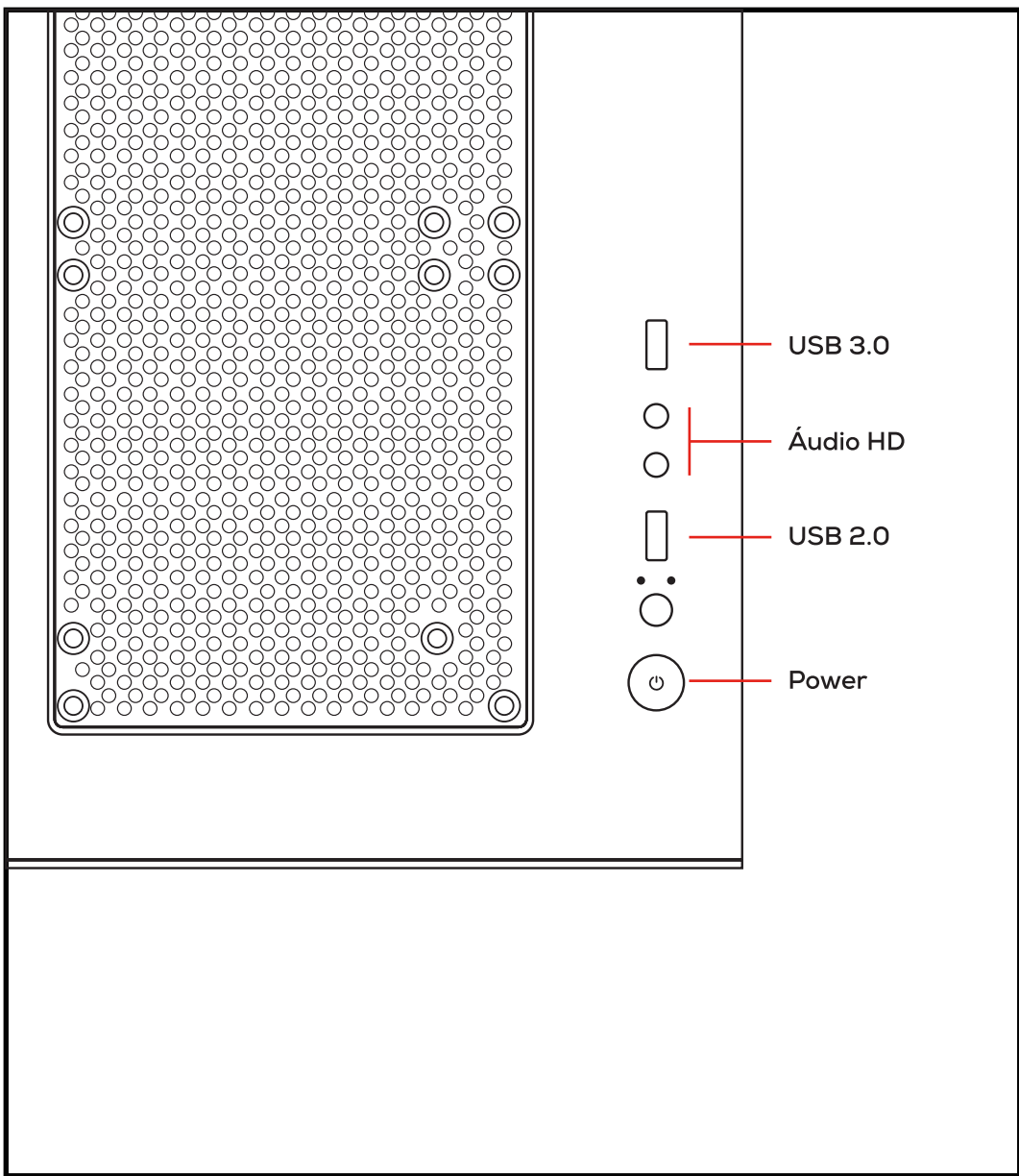

# CONECTORES

Conector de Áudio HD do Gabinete



Conector de Áudio HD da Placa-Mãe

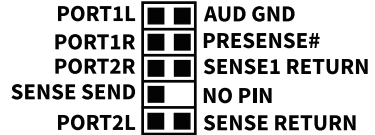

Conector USB 2.0 do Gabinete

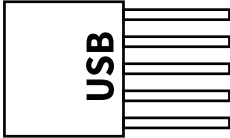

Conector USB 2.0 da Placa-Mãe

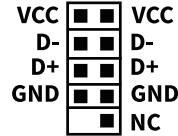

Conector USB 3.0 do Gabinete

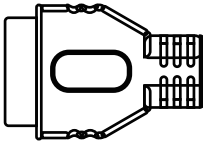

Conector USB 3.0 da Placa-Mãe

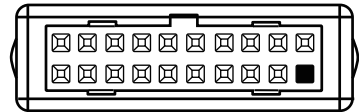

Conector Power/Reset/LED do Gabinete

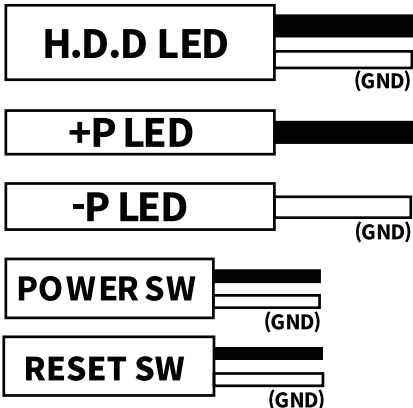

Conector Power/Reset/LED da Placa-Mãe

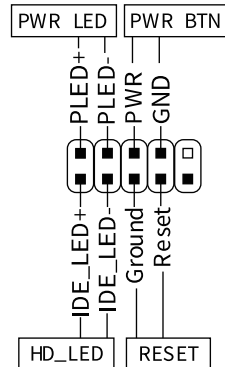

**AGRADECEMOS POR ESCOLHER O PICHAU GROUP  
COMO PARTE DA SUA JORNADA.**

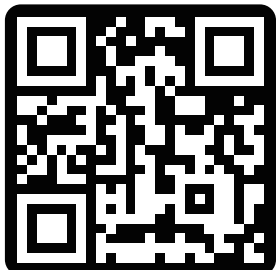

**PICHAU**

**EXPLORE NOSSOS SITES E ENCONTRE O  
PRODUTO IDEAL PARA ELEVAR SUA EXPERIÊNCIA.**



MANUAL | ESPANÖL

---

**MAGPIE 4B**





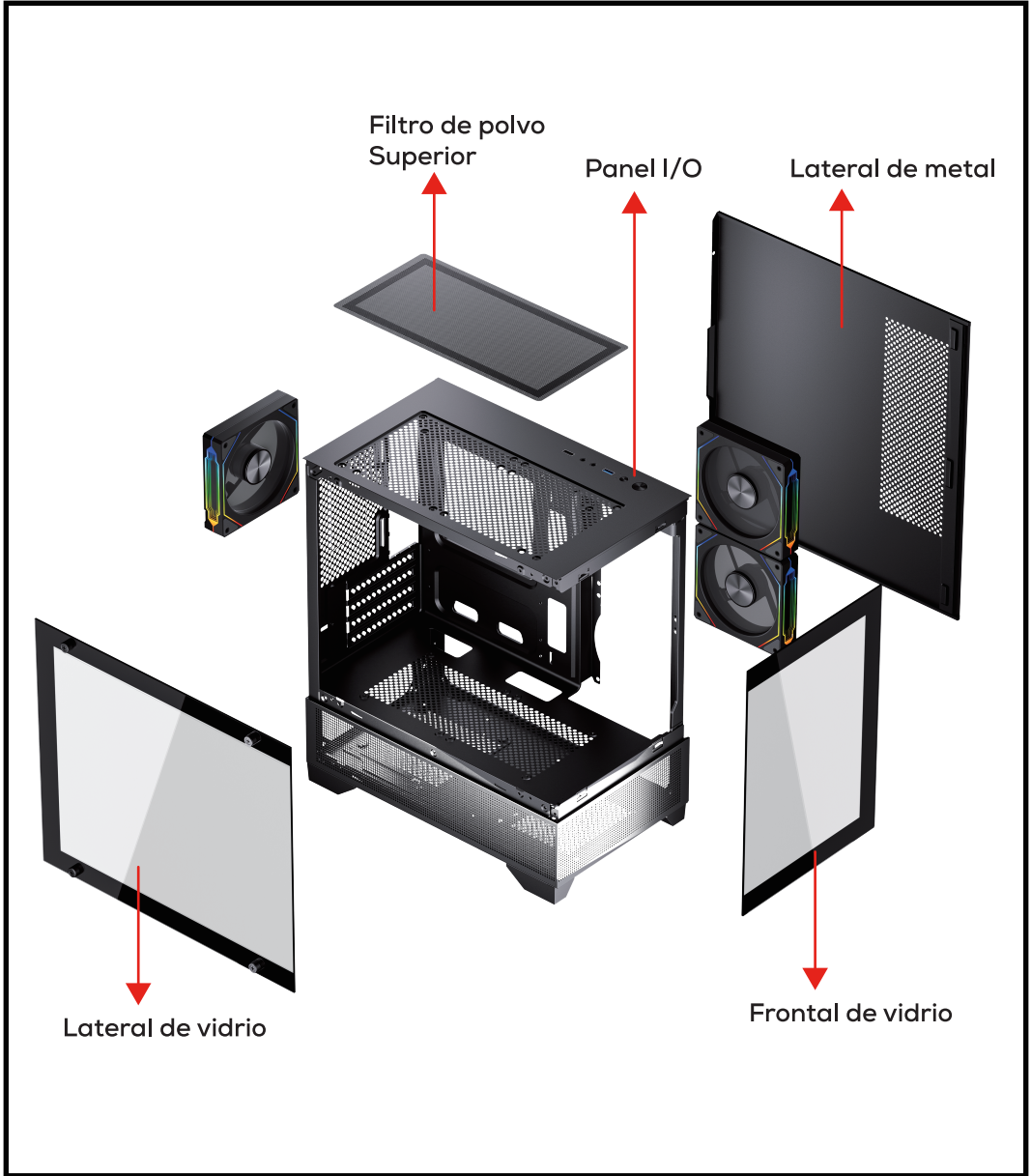

# **IMPORTANTE**

**ES DE SUMO IMPORTANCIA LEER, COMPRENDER Y SEGUIR TODAS LAS INSTRUCCIONES EN ESTE MANUAL. UN MANEJO INCORRECTO PUEDE DAÑAR EL EQUIPO Y DAR LUGAR A LA ANULACIÓN DE LA GARANTÍA.**

# COMPONENTES DEL HARDWARE



# ACCESORIOS

Item	Nombre / Cant.	Utilidad
	Tornillos #6-32 6mm x5	Fuente de Alimentación y Tarjeta de Video
	Tornillos M3 5mm x10	Placa Madre y SSD 2.5"
	Tornillos #6-32 5mm x4	HDD 3.5"
	Separadores #6-32 6.5mm x2	Soporte para Placa Madre
	Tornillos M3 28mm x8	Tornillos para ventiladores

# APERTURA DEL GABINETE

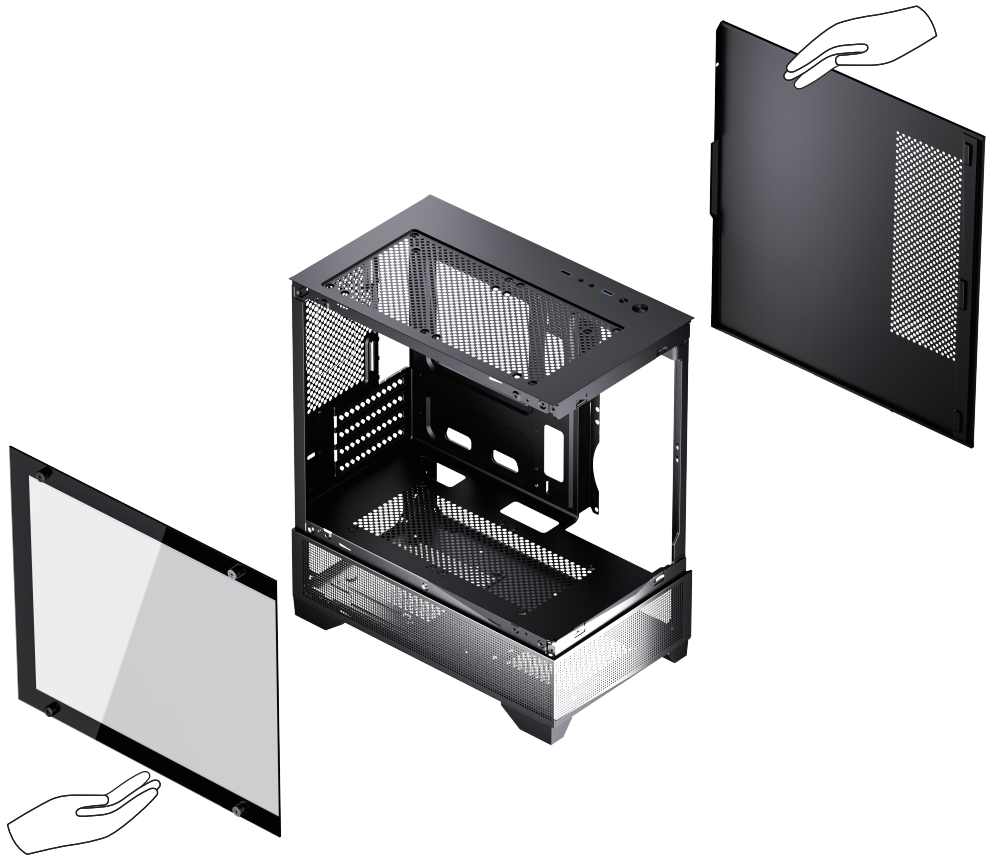

Desatornille y guarde los tornillos ubicados en la parte trasera del gabinete; retire primero los paneles laterales para luego remover la parte superior y la frontal.

## INSTALACIÓN DE LA PLACA MADRE

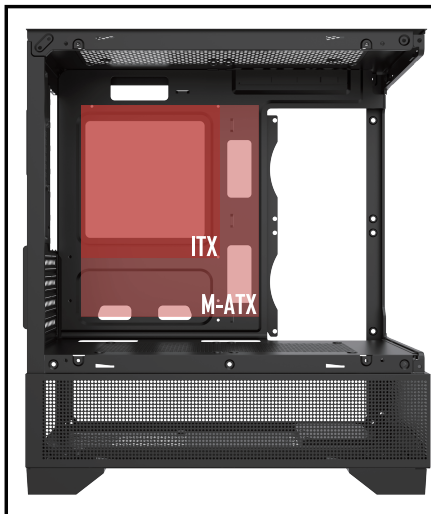

Posicione la Placa Madre alineando sus orificios con los del lugar de instalación, reposicione los separadores si es necesario y fíjela con los tornillos respectivos.

## INSTALACIÓN DE HDD 3.5" Y SSD 2.5"



Posicione el HDD/SSD alineando sus orificios con los del lugar de instalación y fíjelo con los tornillos respectivos.



## INSTALACIÓN DE LOS VENTILADORES



## INSTALACIÓN DE LA FUENTE DE ALIMENTACIÓN



# INSTALACIÓN DE LA TARJETA DE VIDEO



Identifique y retire las cubiertas de los slots de expansión que utilizará el modelo de su Tarjeta de Video, conecte la placa a la Placa Madre y fijela con los tornillos respectivos por la parte trasera del gabinete.

# PANEL I/O

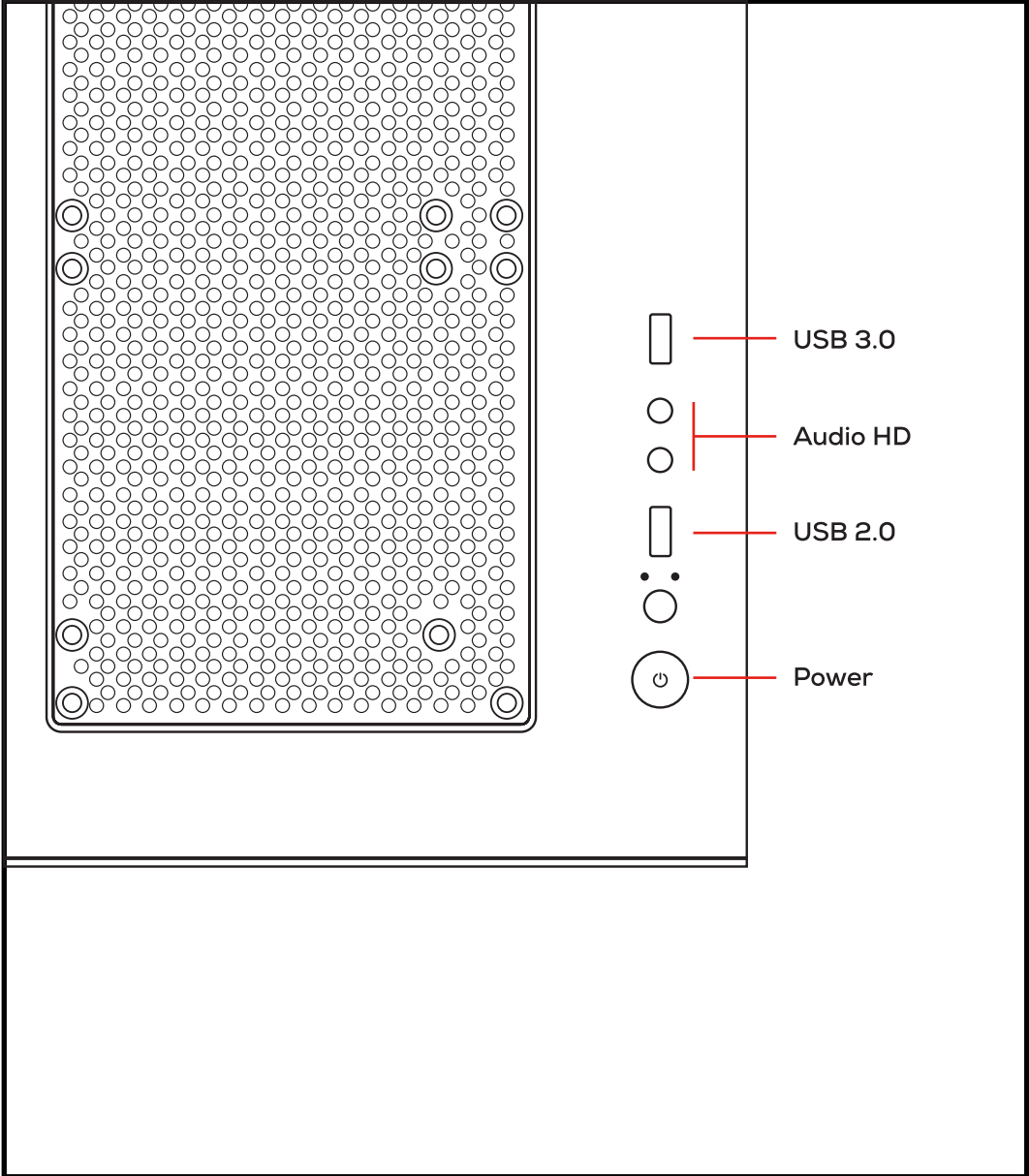



**LE AGRADECEMOS QUE HAYA ELEGIDO A PICHAU GROUP  
COMO PARTE DE SU TRAYECTORIA.**



**PICHAU**

**EXPLORA NUESTRAS PÁGINAS WEB Y ENCUENTRA EL  
PRODUCTO IDEAL PARA MEJORAR TU EXPERIENCIA.**



MANUAL | INGLÊS

---

**MAGPIE 4B**

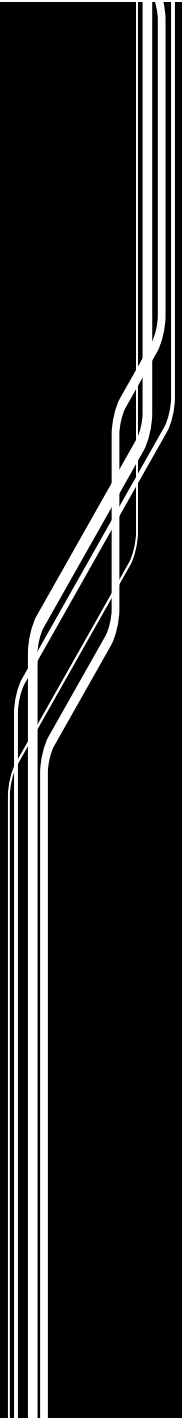



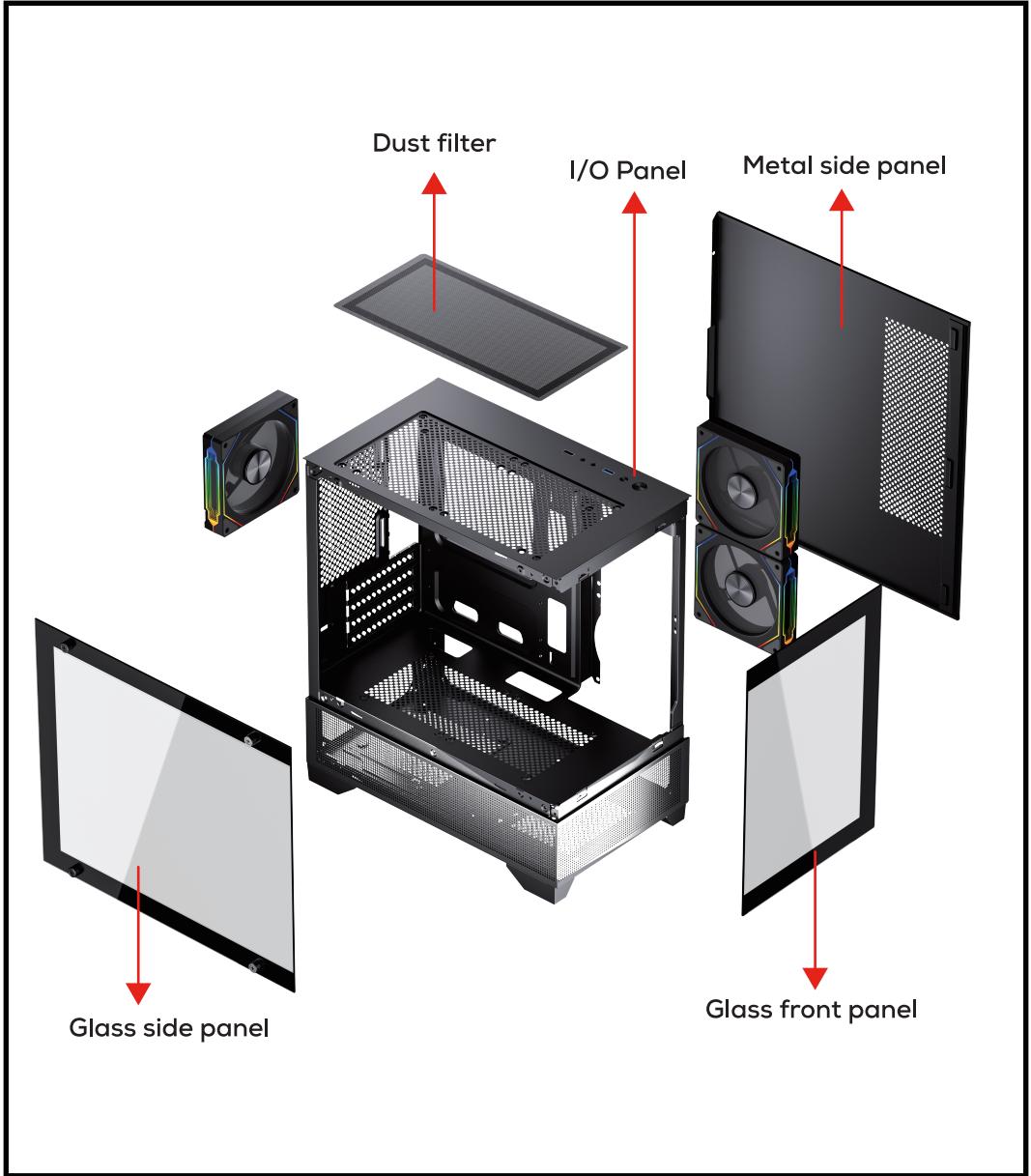

# **IMPORTANT**

**IT IS EXTREMELY IMPORTANT TO READ, UNDERSTAND, AND FOLLOW ALL THE INSTRUCTIONS IN THIS MANUAL. INCORRECT HANDLING MAY DAMAGE THE EQUIPMENT AND VOID THE WARRANTY.**

# CASE COMPONENTS



# ACCESSORIES

Item	Name / Qty.	Utility / Usage
	Screws #6-32 6mm x5	Power Supply and Graphics Card
	Screws M3 5mm x10	Motherboard and 2.5" SSD
	Screws #6-32 5mm x4	3.5" HDD
	Standoffs #6-32 6.5mm x2	Motherboard Support
	Screws M3 28mm x8	Fan Screws

# OPENING THE CASE

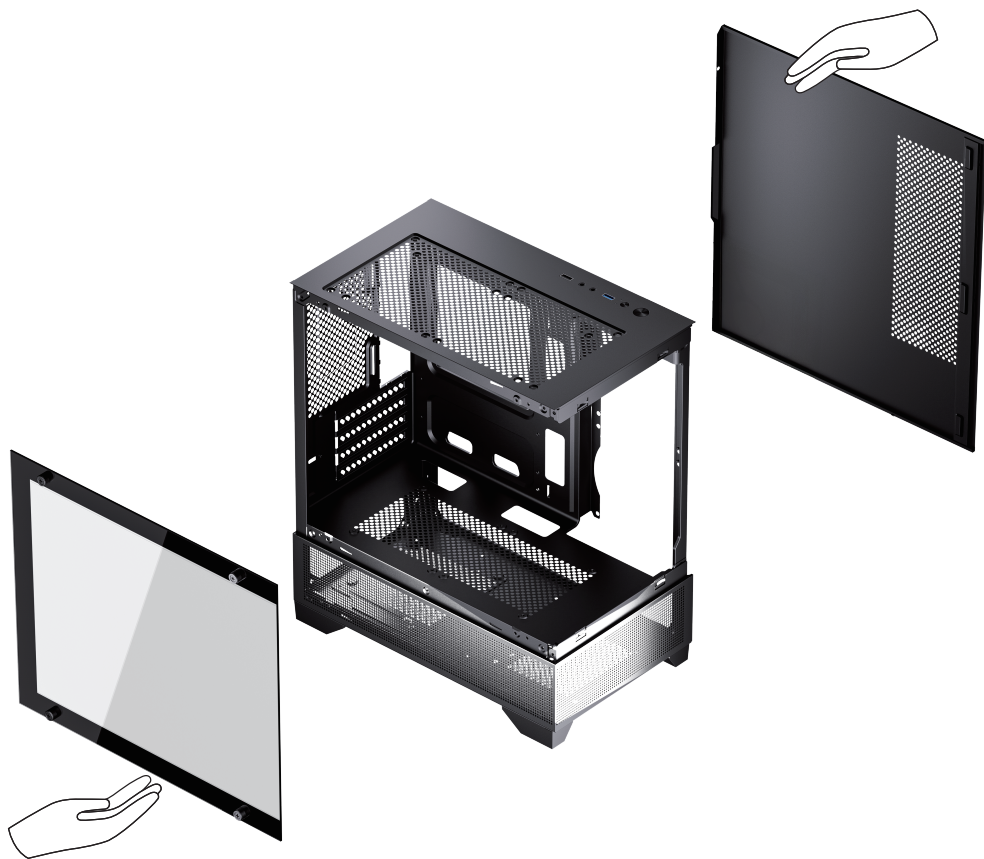

Unscrew and set aside the screws located on the rear of the case; remove the side panels first, then remove the top and front panels.

# MOTHERBOARD INSTALLATION

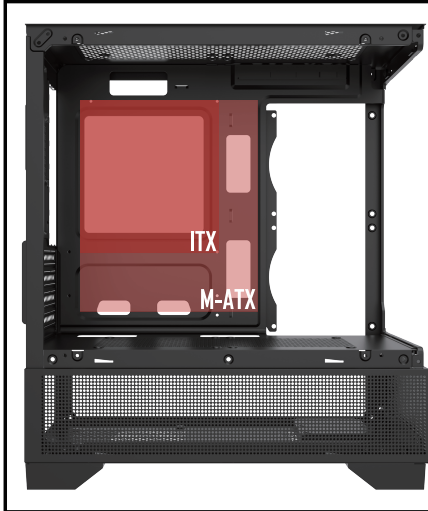

Position the Motherboard by aligning its mounting holes with those on the case, reposition the standoffs if necessary, and secure it with the corresponding screws.

# 3.5" HDD AND 2.5" SSD INSTALLATION

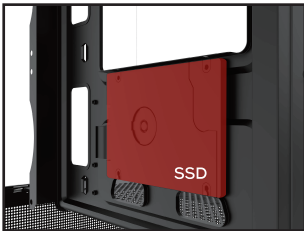

Position the HDD/SSD by aligning its mounting holes with those on the installation site, and secure it with the corresponding screws.



# FAN INSTALLATION

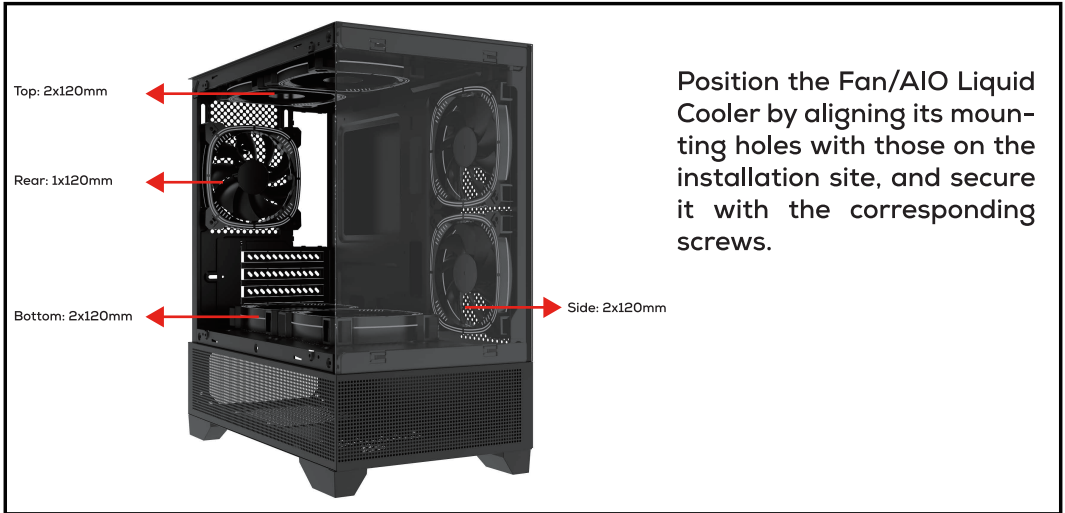

# POWER SUPPLY INSTALLATION (PSU)

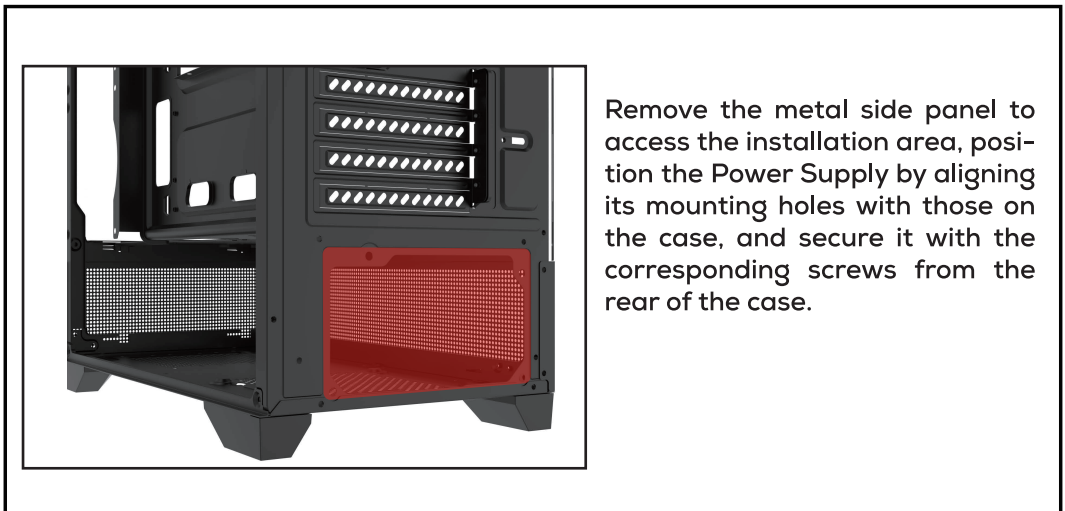

# GRAPHICS CARD INSTALLATION



Identify and remove the expansion slot covers that your Graphics Card model will use, connect the card to the Motherboard, and secure it with the corresponding screws from the rear of the case.

# I/O PANEL

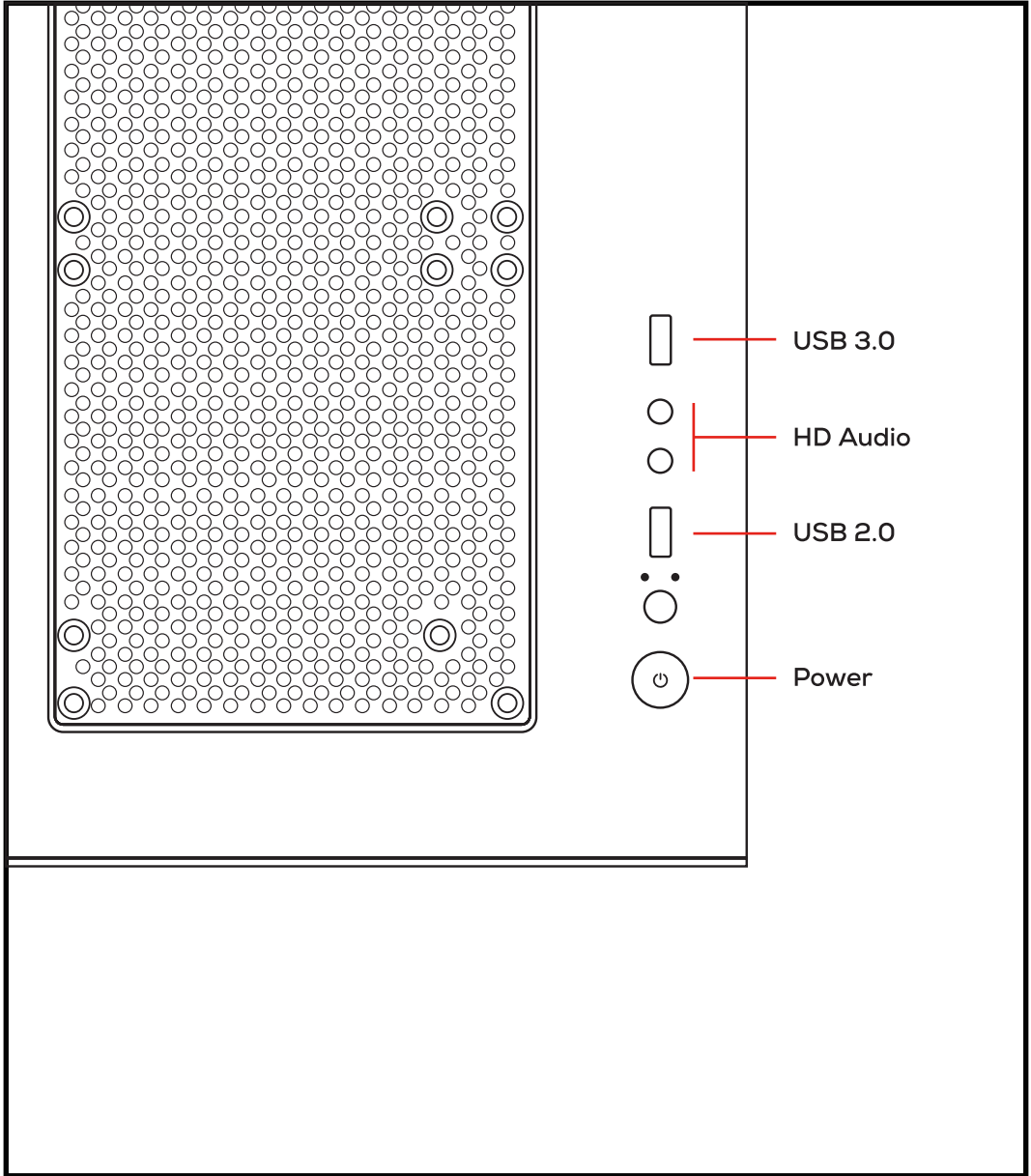

# CONNECTORS

Case HD Audio Connector

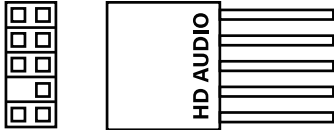

Motherboard HD Audio Connector

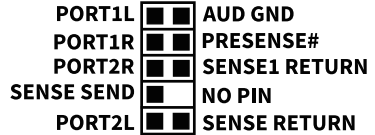

Case USB 2.0 Connector

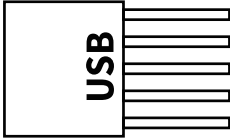

Motherboard USB 2.0 Connector

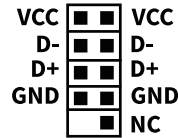

Case USB 3.0 Connector

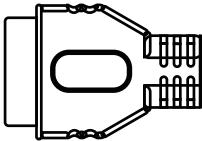

Motherboard USB 3.0 Connector

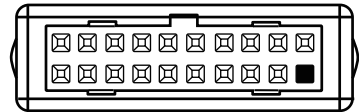

Case Power/Reset/LED Connector

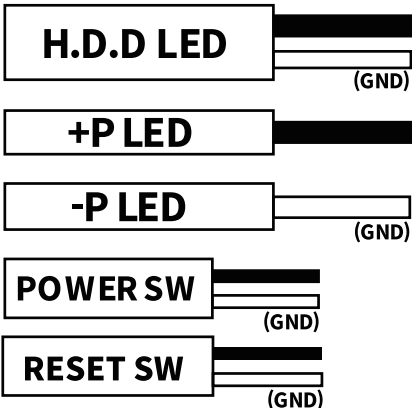

Motherboard Power/Reset/LED Connector

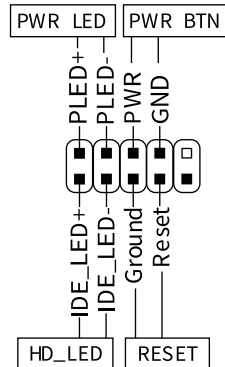

**THANK YOU FOR CHOOSING THE PICHAU GROUP  
AS PART OF YOUR JOURNEY.**



**PICHAU**

**EXPLORE OUR WEBSITES AND FIND THE  
PERFECT PRODUCT TO ENHANCE YOUR EXPERIENCE.**

