

MANUAL

MAGPIE 4X

IMPORTANTE

É de extrema importância ler, compreender e seguir todas as instruções contidas neste manual. O manuseio incorreto pode danificar o equipamento e ocasionar a anulação da garantia.

Acessórios Incluídos

	Abraçadeira X6	Organização dos cabos
	Parafuso de Placa-Mãe x13	Fixação da Placa-Mãe, SSD e extensão do cabo VGA
	Parafuso de Fonte X6	Fixação da Fonte e Placa de Vídeo
	Parafuso de HDD X8	Fixação de HDD
	Espaçador X3	Fixação da Placa-mãe
	Suporte para Espaçador X1	Auxilia na fixação e remoção dos espaçadores
	Slot de Expansão X1	Fixação da Placa de Vídeo

Laterais e Frontal

Remova as laterais pela parte traseira através da marcação indicada nas imagens abaixo:



Marcação no lado esquerdo.



Marcação no lado direito.

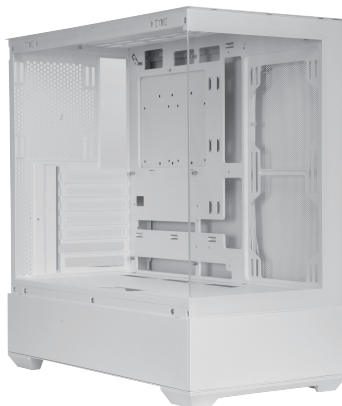

Instalação da Placa-Mãe

Posicione a Placa-Mãe alinhando suas furações com as do gabinete, reposicione os espaçadores se necessário, e fixe com os respectivos parafusos.

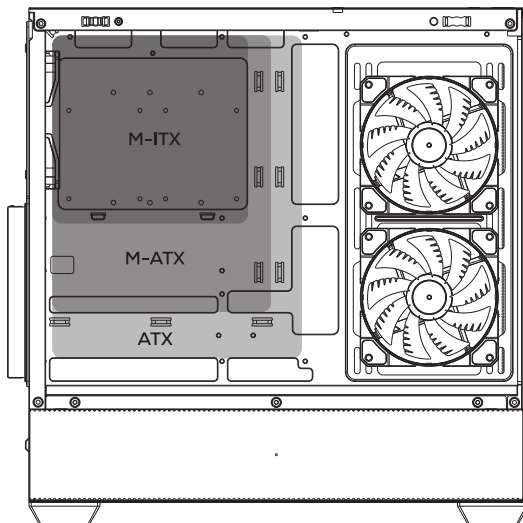

Suporte de HDD 3.5" e SSD 2.5" (Suporte 1)

Acesse o suporte através da lateral direita do gabinete. Desparafuse e solte o suporte.
Posicione o HDD/SSD no suporte e fixe com os parafusos.

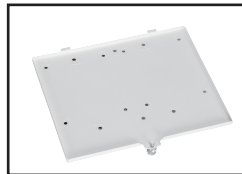

Instalação de HDD 3.5" (Suporte 2)

Acesse o local de instalação através da lateral direita do gabinete. Posicione o HDD no local e fixe com os parafusos.



Instalação das Ventoinhas e Water Cooler:

Posicione a Ventoinha/Water Cooler alinhando suas furações com as do local de instalação, e fixe com os respectivos parafusos.

Suporte de Ventoinha superior: 3x 120mm ou 2x 140mm.
Suporte de Water Cooler superior: 240m/280/360mm.

Suporte de ventoinha traseiro:
1x 120mm ou 1x 140mm.
Suporte de Water Cooler
traseiro: 120mm

Suporte de ventoinha inferior:
3x 120mm ou 2x 140mm.

Suporte de ventoinha lateral:
2x 120mm ou 2x 140mm.

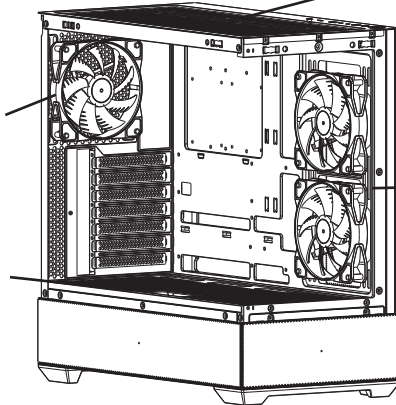

Instalação da Fonte de Alimentação

Posicione a Fonte de Alimentação alinhando suas furações com as do local de instalação, e fixe com os respectivos parafusos pela parte traseira do gabinete.

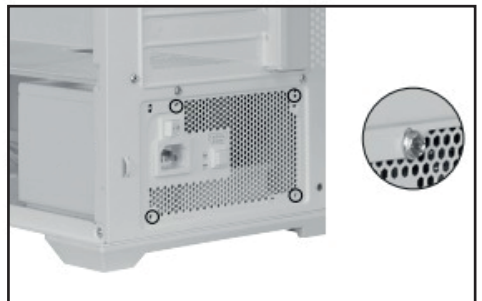

Instalação da Placa de Vídeo

Identifique e remova os slots de expansão que o modelo da Placa de Vídeo irá utilizar, instale a Placa de Vídeo na Placa-Mãe, e fixe com os respectivos parafusos pela parte traseira do gabinete.



Painel I/O e Conectores

Conectores inclusos:

USB 3.0

HD ÁUDIO

Controle de LED

F_PANEL: Power/Reset/LED

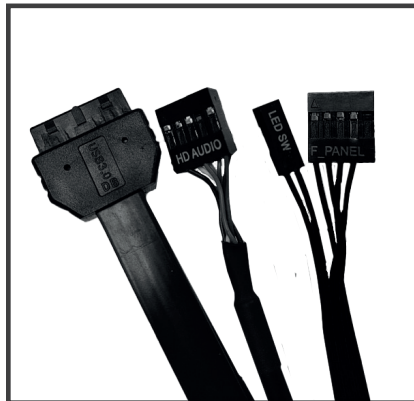

Realize a conexão dos cabos “F_PANEL”, “HD AUDIO” e “USB 3.0” do gabinete na Placa-Mãe.

O conector “LED SW” pode ser conectado na controladora para ajuste do LED através do botão do painel I/O

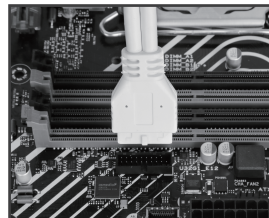
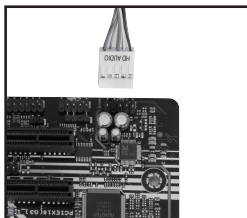
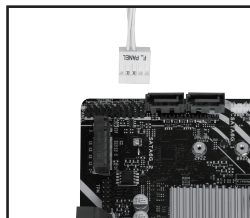

**AGRADECEMOS POR ESCOLHER O PICHAU GROUP
COMO PARTE DA SUA JORNADA.**



**EXPLORE NOSSOS SITES E ENCONTRE O
PRODUTO IDEAL PARA ELEVAR SUA EXPERIÊNCIA.**



MANUAL | ESPANÖL

MAGPIE 4X

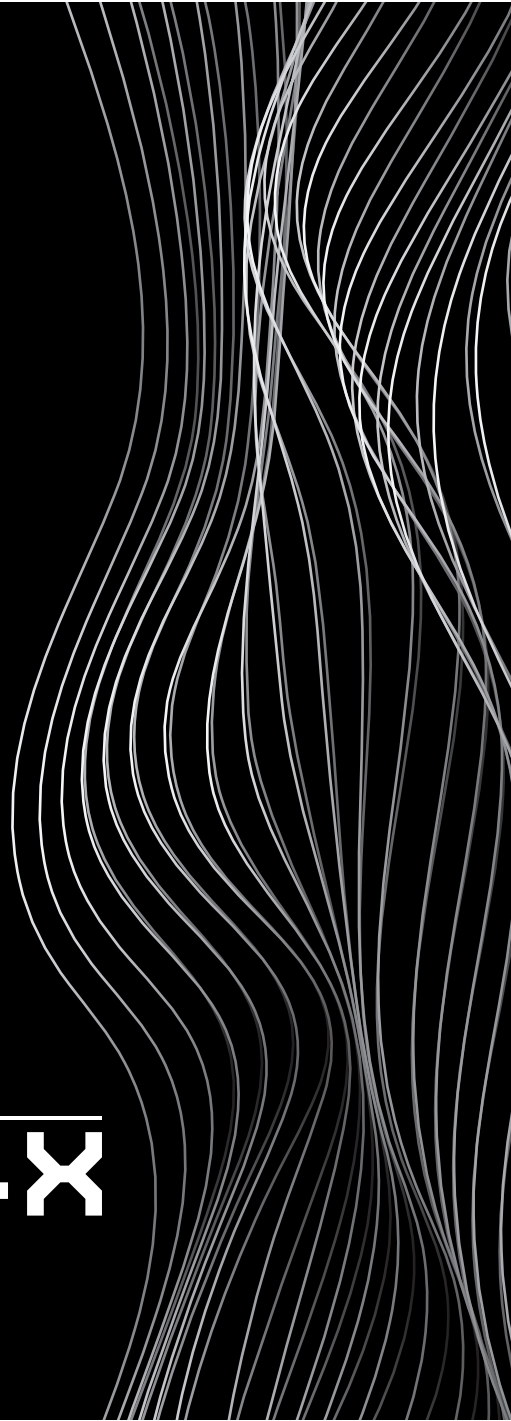

IMPORTANTE

ES DE SUMA IMPORTANCIA LEER, COMPRENDER Y SEGUIR TODAS LAS INSTRUCCIONES EN ESTE MANUAL. UN MANEJO INCORRECTO PUEDE DAÑAR EL EQUIPO Y DAR LUGAR A LA ANULACIÓN DE LA GARANTÍA.

Accesorios incluidos

	Precintos X6	Organización de cables
	Tornillos de Placa Madre x13	Fijación de Placa Madre, SSD y extensión de cable VGA
	Tornillos de Fuente X6	Fijación de la Fuente y Tarjeta de Video
	Tornillos de HDD X8	Fijación de HDD
	Separadores X3	Fijación de la Placa Madre
	Soporte para Separadores X1	Ayuda en la fijación y remoción de los separadores
	Slot de Expansión X1	Fijación de la Tarjeta de Video

Laterales y Frontal

Retire los paneles laterales desde la parte trasera a través de la marca indicada en las imágenes a continuación:



Marca en el lado izquierdo.



Marca en el lado derecho.

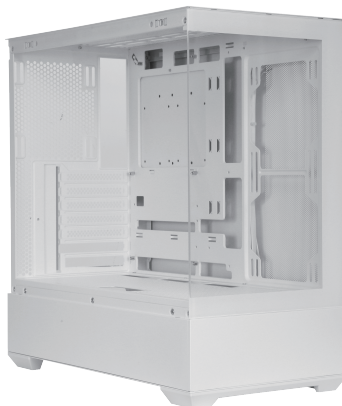

INSTALACIÓN DE LA PLACA MADRE

Posicione la Placa Madre alineando sus orificios con los del lugar de instalación, reposicione los separadores si es necesario y fija con los tornillos respectivos.

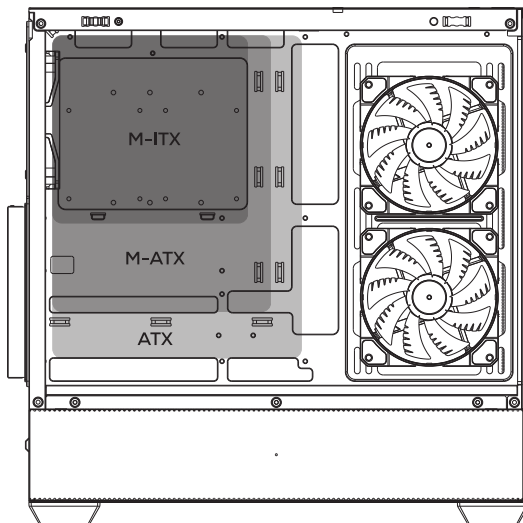

Soporte de HDD 3.5" y SSD 2.5" (Soporte 1)

Acceda al soporte a través del lateral derecho del gabinete. Desatornille y suelte el soporte. Posicione el HDD/SSD en el soporte y fíjelo con los tornillos.

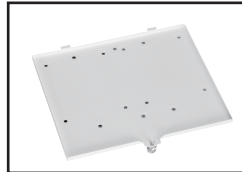

Instalación de HDD 3.5" (Soporte 2)

Acceda al lugar de instalación a través del lateral derecho del gabinete. Posicione el HDD en el lugar y fíjelo con los tornillos.



Instalación de los Ventiladores y Water Cooler:

Posicione el Ventilador/Water Cooler alineando sus orificios con los del lugar de instalación, y fíjelo con los respectivos tornillos.

Soporte de ventilador superior: 3x 120mm o 2x 140mm.
Soporte de Water Cooler superior: 240m/280/360mm.

Soporte de ventilador trasero:
1x 120mm o 1x 140mm.
Soporte de Water Cooler trasero: 120mm

Soporte de ventilador inferior:
3x 120mm o 2x 140mm.

Soporte de ventilador lateral:
2x 120mm o 2x 140mm.

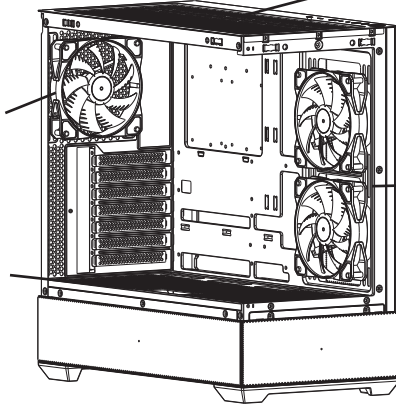

INSTALACIÓN DE LA FUENTE DE ALIMENTACIÓN

Posicione la Fuente de Alimentación alineando sus orificios con los del lugar de instalación, y fíjela con los tornillos respectivos por la parte trasera del gabinete.

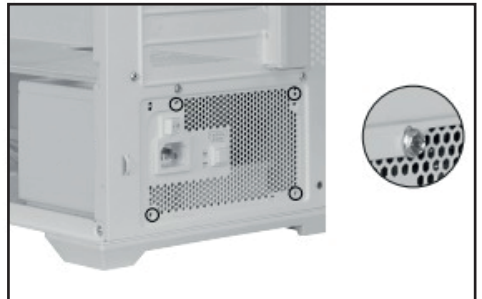

Instalación De La Tarjeta De Video

Identifique y retire las cubiertas de los slots de expansión que utilizará el modelo de su Tarjeta de Video, conecte la placa a la Placa Madre y fíjela con los tornillos respectivos por la parte trasera del gabinete.

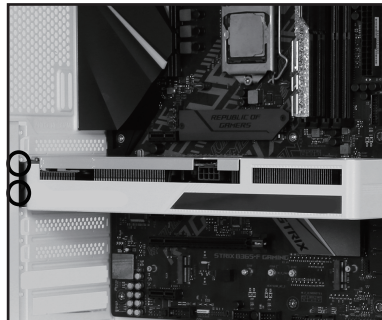

Panel I/O y Conectores

Conectores incluidos:
USB 3.0
HD AUDIO
Control de LED
F_PANEL: Power/Reset/LED



Realice la conexión de los cables “F_PANEL”, “HD AUDIO” y “USB 3.0” del gabinete en la placa madre.

El conector “LED SW” puede conectarse a la controladora para ajustar el LED a través del botón del panel I/O.

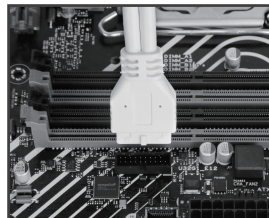
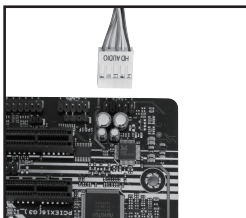
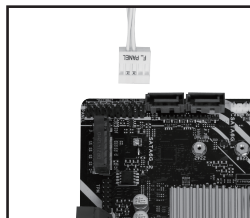

**LE AGRADECEMOS QUE HAYA ELEGIDO A PICHAU GROUP
COMO PARTE DE SU TRAYECTORIA.**



**EXPLORA NUESTRAS PÁGINAS WEB Y ENCUENTRA EL
PRODUCTO IDEAL PARA MEJORAR TU EXPERIENCIA.**



MANUAL | ENGLISH

MAGPIE 4X

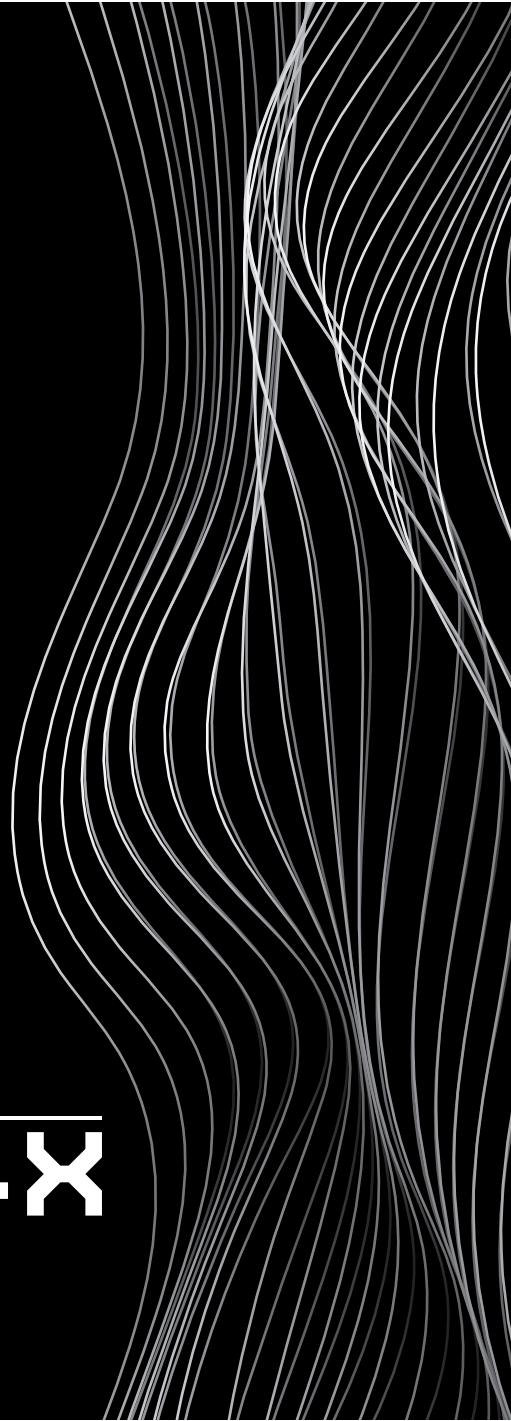

IMPORTANT

IT IS EXTREMELY IMPORTANT TO READ, UNDERSTAND, AND FOLLOW ALL THE INSTRUCTIONS IN THIS MANUAL. IMPROPER HANDLING MAY DAMAGE THE EQUIPMENT AND VOID THE WARRANTY.

Included Accessories

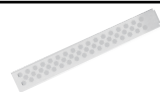
	Zip ties X6	Cable management
	Motherboard Screws x13	Motherboard, SSD, and VGA cable extension mounting
	Power Supply Screws X6	PSU and Graphics Card mounting
	HDD Screws X8	HDD mounting
	Standoffs X3	Motherboard mounting
	Standoff Socket X1	Assists in installing and removing standoffs
	Expansion Slot Cover X1	Graphics Card mounting

Side and Front Panels

Remove the side panels from the rear using the indentation shown in the images below:



Left side indentation.



Right side indentation.



MOTHERBOARD INSTALLATION

Position the Motherboard by aligning its mounting holes with those on the case, reposition the standoffs if necessary, and secure it with the corresponding screws.

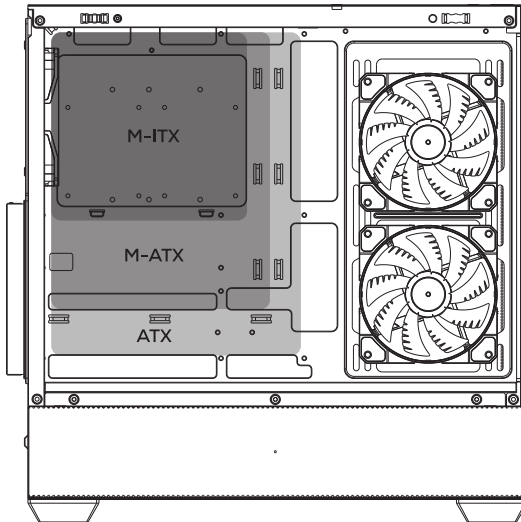

3.5" HDD and 2.5" SSD Bracket (Bracket 1)

Access the bracket through the right side of the case. Unscrew and release the bracket. Position the HDD/SSD on the bracket and secure it with the screws.

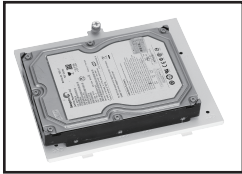

3.5" HDD Installation (Bracket 2)

Access the installation site through the right side of the case. Position the HDD in place and secure it with the screws.

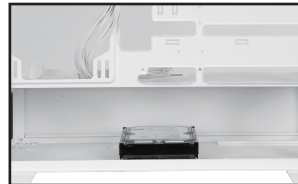

Fan and Liquid Cooler Installation:

Position the Fan/Liquid Cooler by aligning its mounting holes with those on the case, and secure it with the corresponding screws.

Top fan support: 3x 120mm ou 2x 140mm.
Top Liquid Cooler support: 240m/280/360mm.

Rear fan support:
1x 120mm ou 1x 140mm.
Rear Liquid Cooler support:
120mm

Bottom fan support:
3x 120mm ou 2x 140mm.

Side fan support:
2x 120mm ou 2x 140mm.

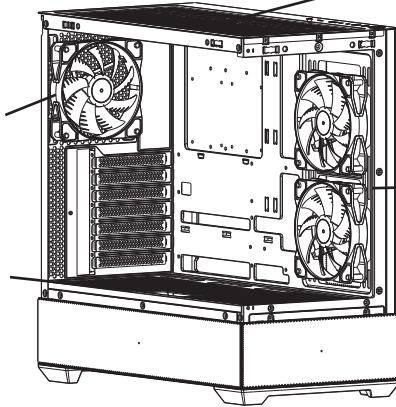

POWER SUPPLY INSTALLATION (PSU)

Position the Power Supply by aligning its mounting holes with those on the case, and secure it with the corresponding screws from the rear of the case.

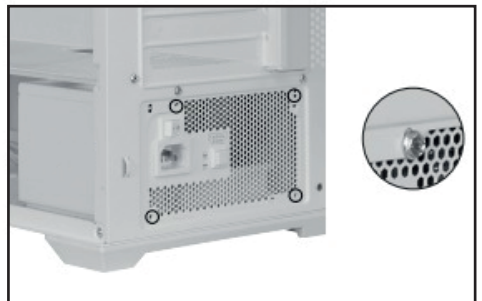

Graphics Card Installation

Identify and remove the expansion slot covers that your Graphics Card model will use, connect the card to the Motherboard, and secure it with the corresponding screws from the rear of the case.

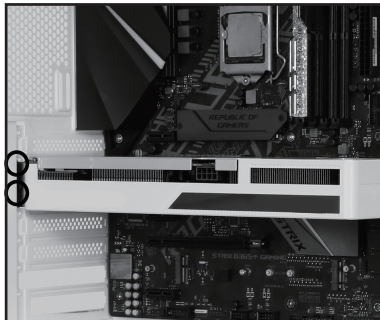

I/O Panel and Connectors

Included connectors:
USB 3.0
HD AUDIO
LED Control
F_PANEL: Power/Reset/LED



Connect the “F_PANEL”, “HD AUDIO”, and “USB 3.0” cables from the case to the motherboard.

The “LED SW” connector can be connected to the controller to adjust the LED lighting via the I/O panel button.

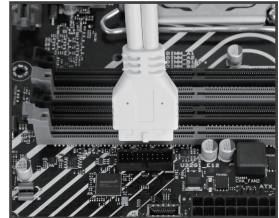
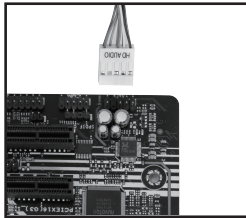
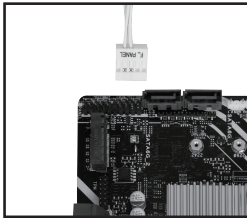

**THANK YOU FOR CHOOSING THE PICHAU GROUP
AS PART OF YOUR JOURNEY.**

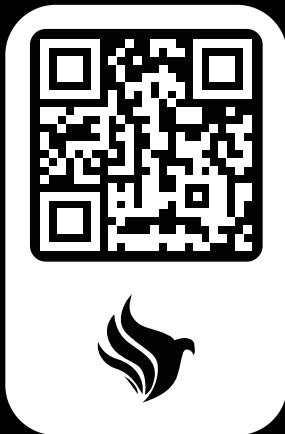

**EXPLORE OUR WEBSITES AND FIND THE
PERFECT PRODUCT TO ENHANCE YOUR EXPERIENCE.**

