



MANUAL DE MONTAGEM

POUTER 3



IMPORTANTE

É DE EXTREMA IMPORTÂNCIA LER, COMPREENDER E SEGUIR TODAS AS INSTRUÇÕES CONTIDAS NESTE MANUAL. O MANUSEIO INCORRETO PODE DANIFICAR O EQUIPAMENTO E OCASIONAR A ANULAÇÃO DA GARANTIA.

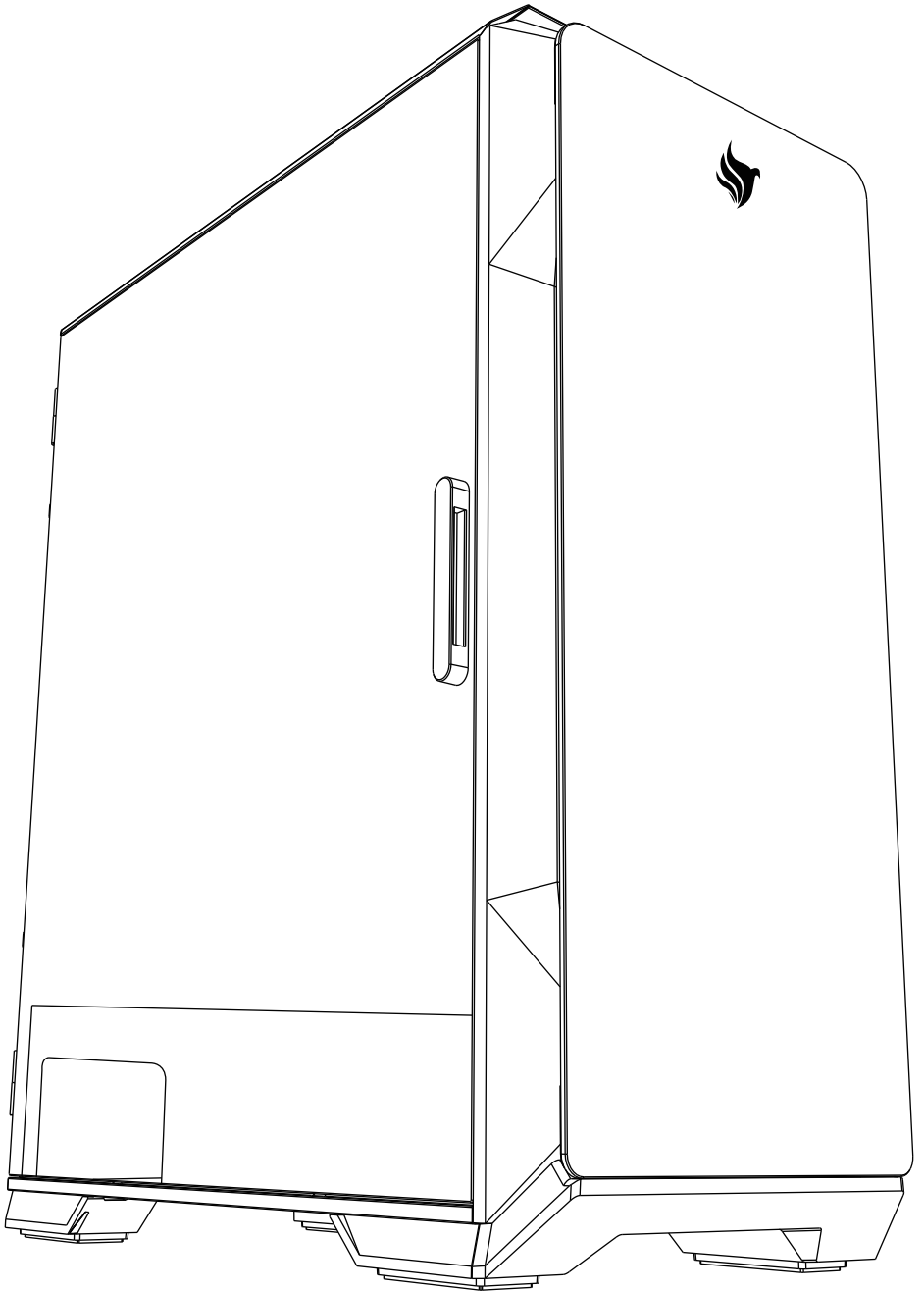

DETALHES DO GABINETE

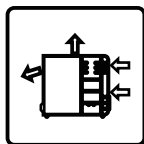
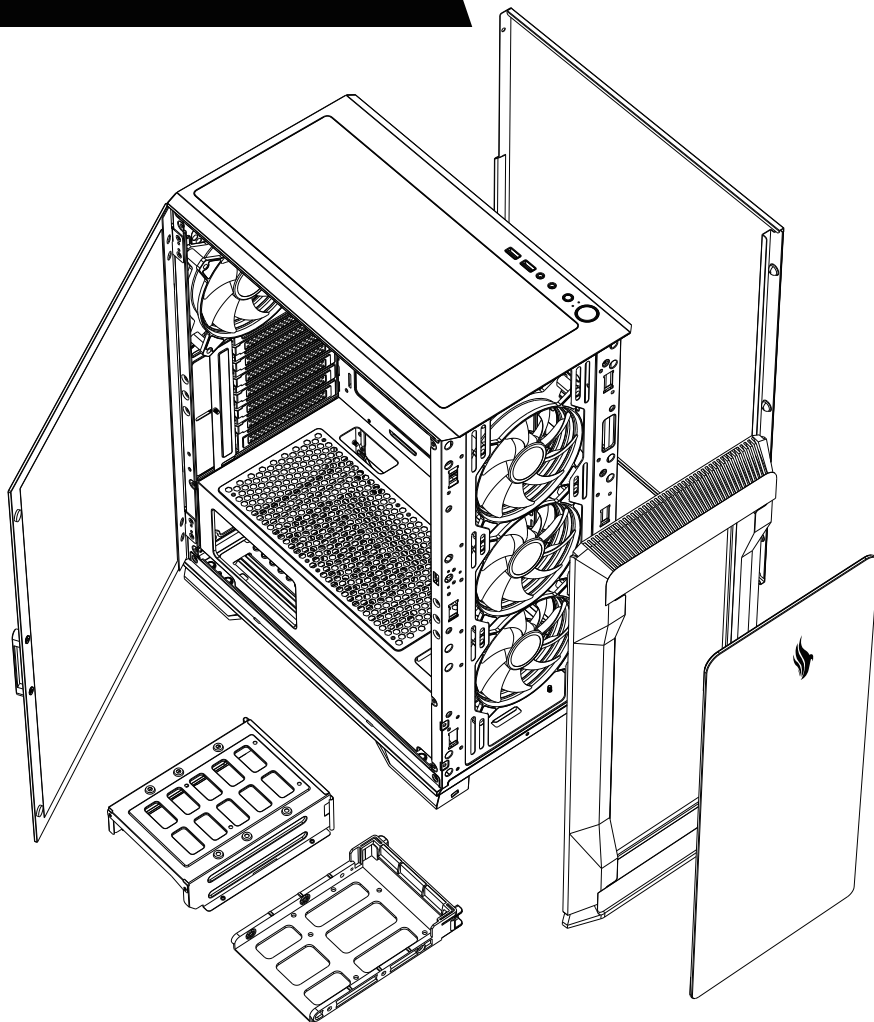

Fluxo de ar
otimizado

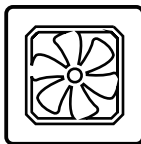

Ventoinhas
inclusas















Lateral de
vidro com
dobradiça, livre
de parafusos



Filtro
Magnético

ACESSÓRIOS

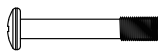
Item	Nome/Quantidade	Utilização
	Abraçadeiras X5	Gerenciamento dos Cabos
 	Parafuso #6-32 10mm X2	Fixação do HDD Rígido
 	Parafuso #6-32 6.5mm X4	Espaçadores para fixação da Placa-Mãe
 	Parafuso M3 5mm X20	Fixação da Placa-Mãe ou SSD
 	Parafuso #6-32 6mm X6	Fixação da Fonte ou Placa de Vídeo
 	Parafuso #6-32 5mm X4	Fixação de HDD
 	Parafuso M3 28mm X4	Fixação de Ventoinhas

MONTAGEM - PASSO A e B

Passo A - Remoção das laterais e o painel frontal

Remova primeiramente as laterais, para então remover a frontal.

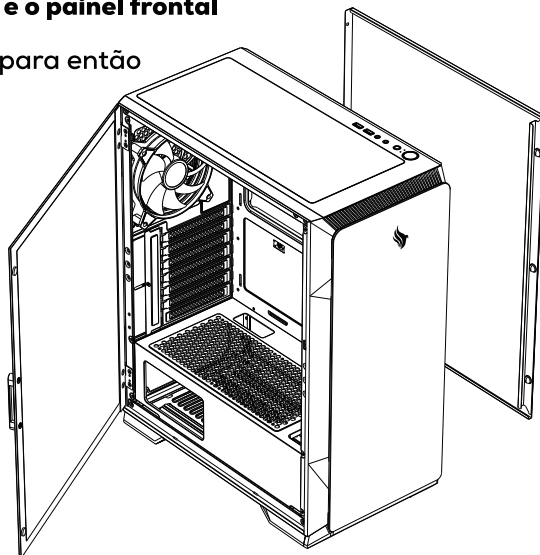

Passo B - Instalação da Fonte de Energia

Ao instalar certifique-se de que a ventoinha da fonte esteja alinhada com a área destinada.

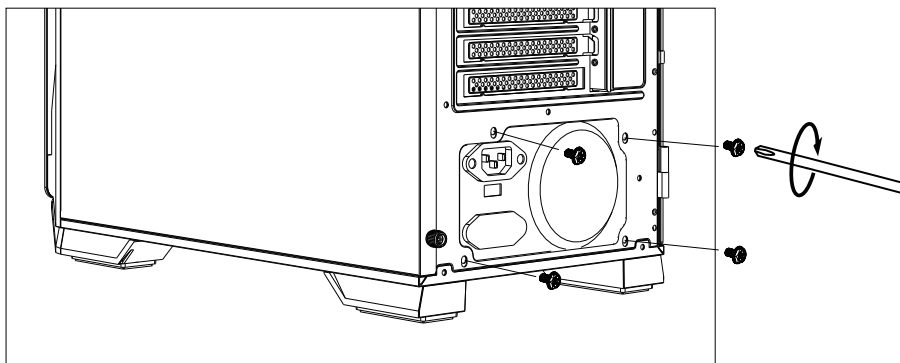

Parafuso #6-32 6mm

Fixação da Fonte e Placas PCI-e

MONTAGEM - PASSO C e D

Passo C - Instalação da Placa-Mãe

Certifique-se de alinhar os pontos de fixação da placa-mãe com os espaçadores e fixar utilizando os parafusos M3 5mm.



Parafuso M3 5mm

Placa-Mãe / SSD



Parafuso #6-32 6.5mm

Espaçadores para fixação
da Placa-Mãe

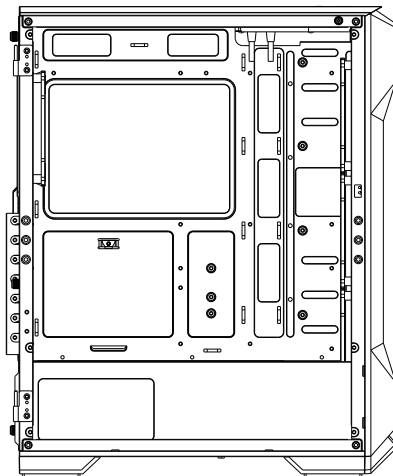

Passo D - Instalação das Ventoinhas

Frontal: 3x 120mm / 2x 140mm

Traseira: 1x 120mm

Superior: 2x 120mm / 2x 140mm

Inferior: 1x 120mm

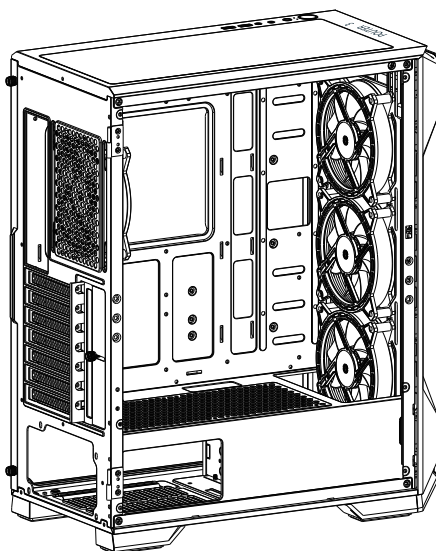

MONTAGEM - PASSO E

Passo E - Instalação de HDD e SSD

Suporte de fixação para HDD e SSD: Desparafuse o suporte, remova-o e instale o HDD ou SSD com os parafusos adequados.

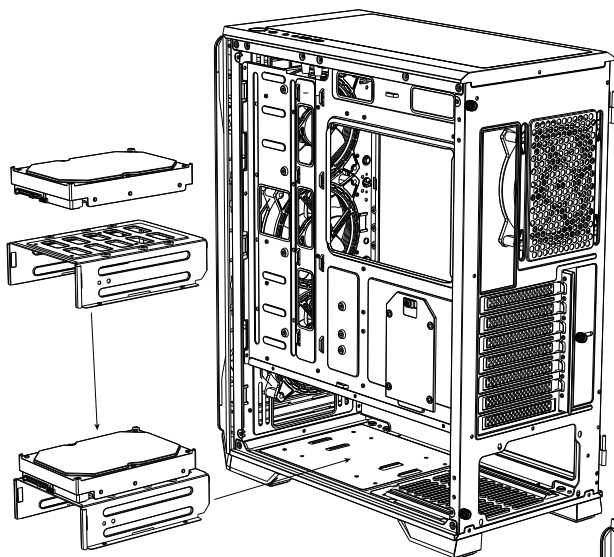

Parafuso #6-32 5mm

HDD 3.5"

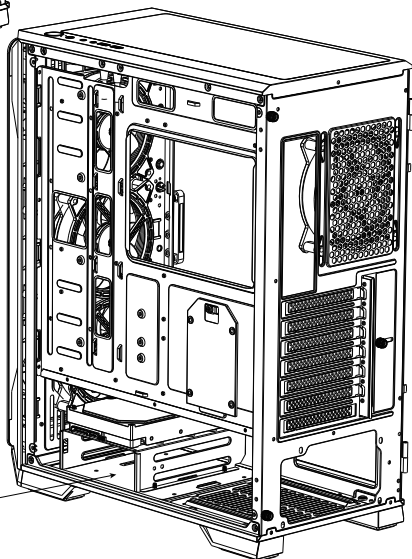
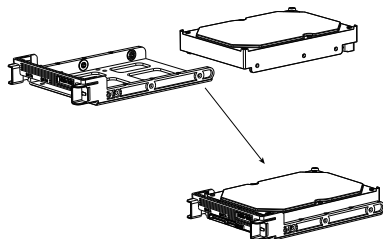

MONTAGEM - PASSO F e G

Passo F - Instalação de SSD

Suporte para instalação de SSD: Remova o suporte e instale o SSD com os parafusos adequados.



Parafuso M3 5mm

Placa-Mãe / SSD

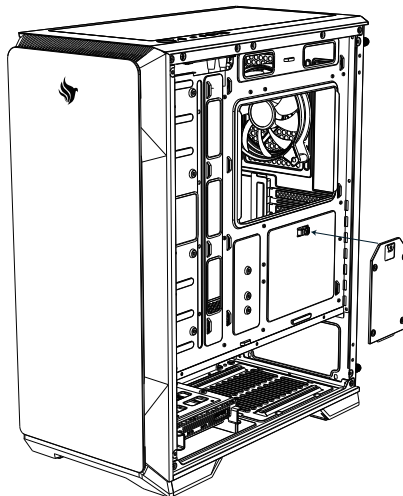

Passo G - Instalação de Placa de Vídeo

Remova o defletor marcado na imagem, certifique-se de alinhar a placa de vídeo com o slot correto e com as saídas do gabinete, encaixe-a e então parafuse-a.

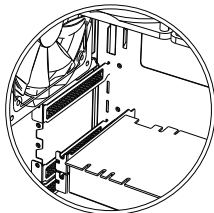
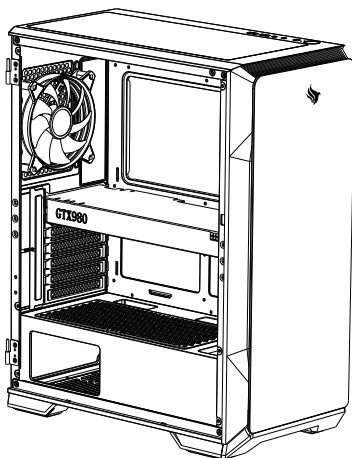

Parafuso #6-32 6mm

Fixação da Fonte ou Placas PCI-e

PAINEL SUPERIOR E CONECTORES

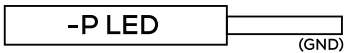
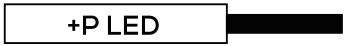
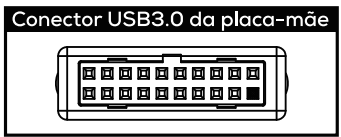
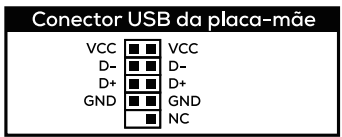
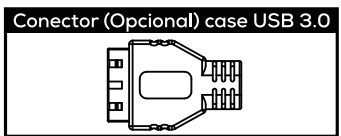
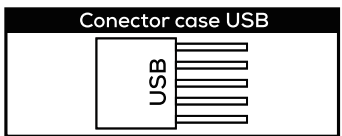
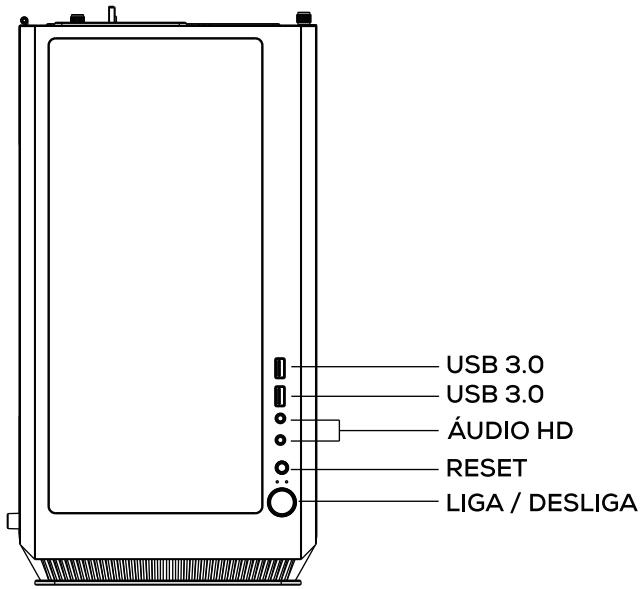

**AGRADECEMOS POR ESCOLHER O PICHAU GROUP
COMO PARTE DA SUA JORNADA.**

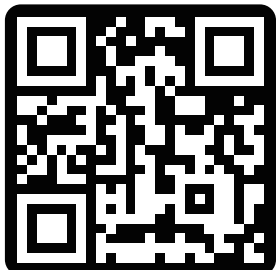

PICHAU

**EXPLORE NOSSOS SITES E ENCONTRE O
PRODUTO IDEAL PARA ELEVAR SUA EXPERIÊNCIA.**



ASSEMBLY MANUAL

POUTER 3

IMPORTANT

IT IS EXTREMELY IMPORTANT TO READ, UNDERSTAND, AND FOLLOW ALL INSTRUCTIONS CONTAINED IN THIS MANUAL. FAILURES CAUSED BY INCORRECT HANDLING MAY RESULT IN DAMAGE TO THE EQUIPMENT AND POSSIBLE VOIDING OF THE WARRANTY.

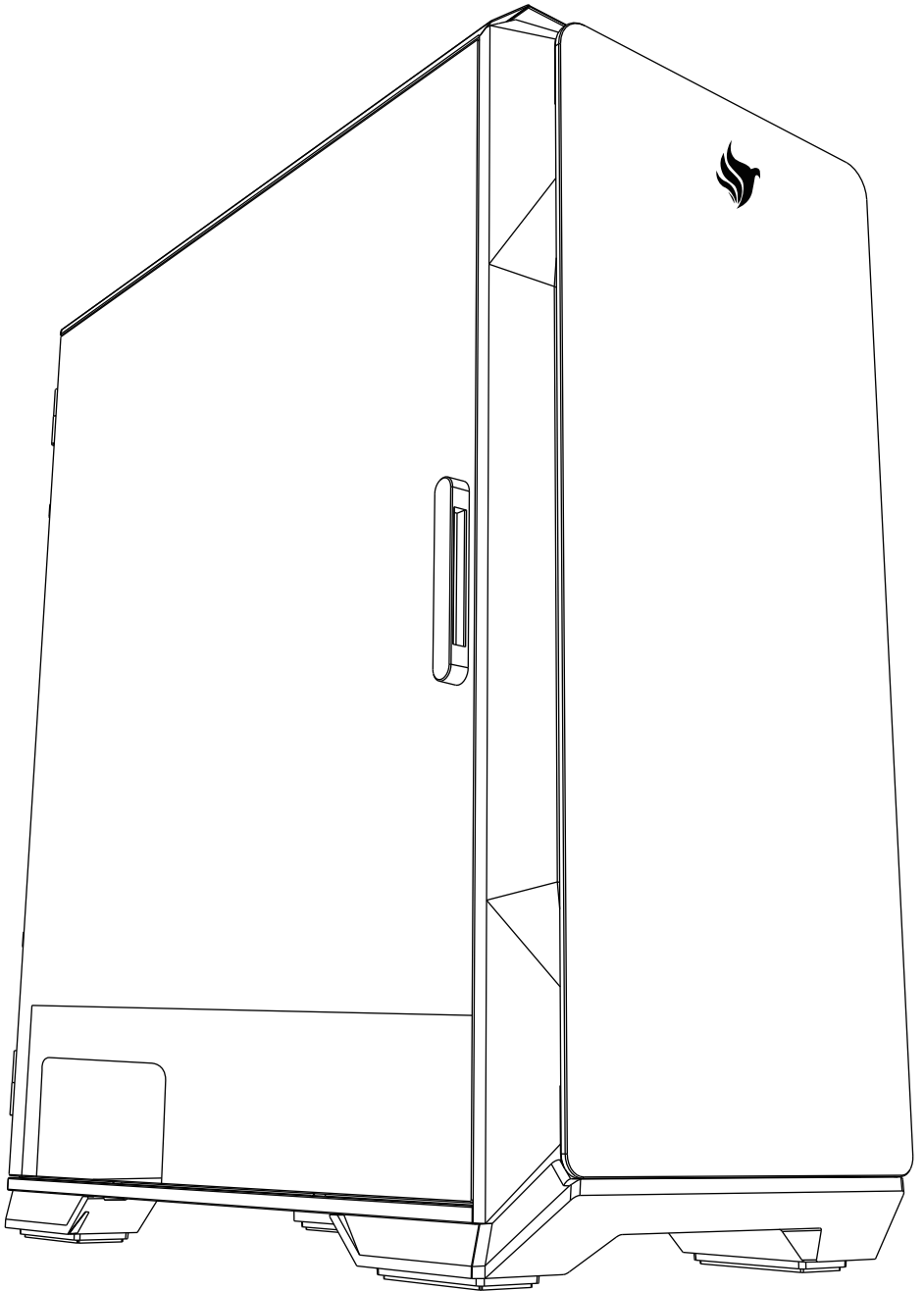

CASE DETAILS

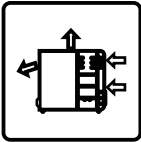
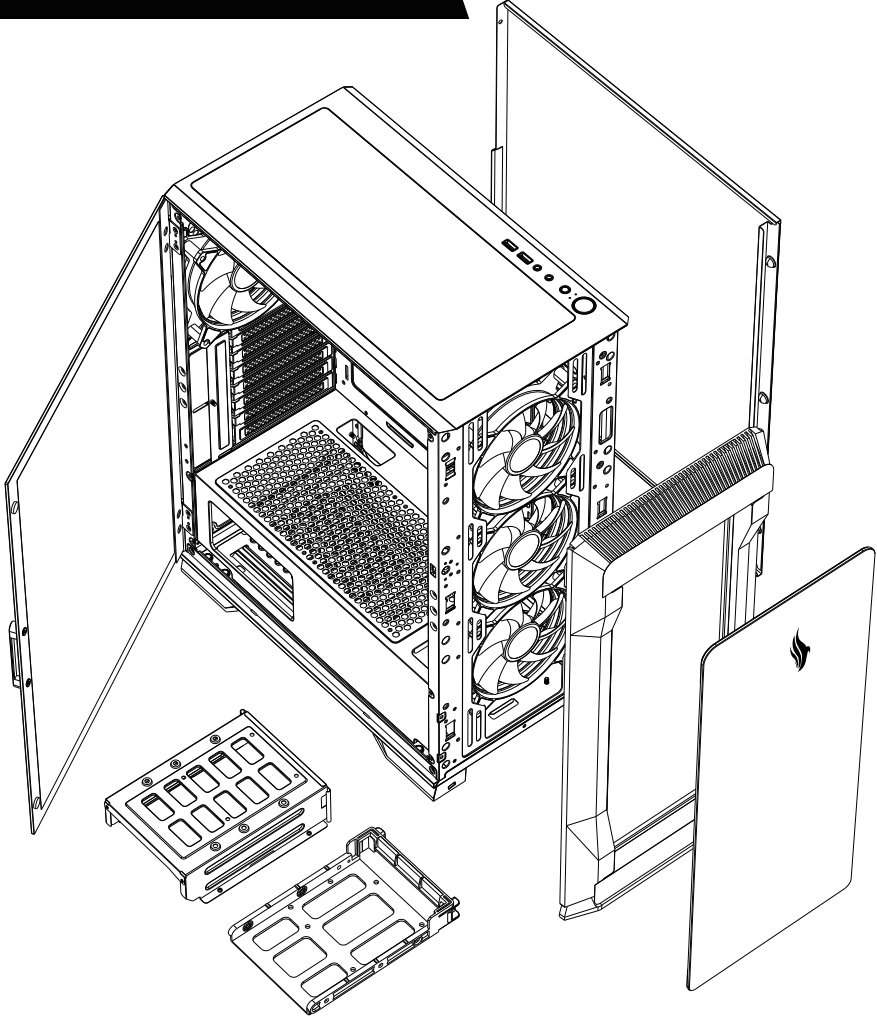

Optimized
Airflow

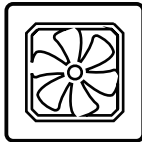

Pre-installed
cooling fans
included









Tool-free empered glass
side panel with a hinged
swing-door design.



Magnetic
dust filter

ACCESSORIES

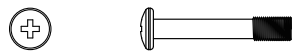
Item	Name / Qty.	Utility
	Zip Ties X5	Cable Management
	#6-32 10mm Screw X2	HDD Mounting
	#6-32 6.5mm Standoffs X4	Motherboard Standoffs
	M3 5mm Screw X20	Motherboard or SSD Mounting
	#6-32 6mm Screw X6	PSU or Graphics Card Mounting
	#6-32 5mm Screw X4	HDD Mounting
	M3 28mm Screw X4	Fan Mounting

ASSEMBLY – STEPS A and B

Step A – Removing the side and front panels

Remove the side panels first, then remove the front panel.

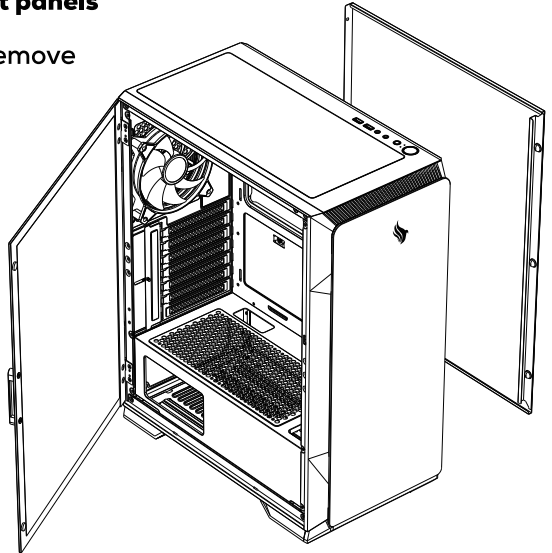

Step B – Power Supply (PSU) Installation

When installing, ensure the power supply fan is aligned with the designated ventilation area.

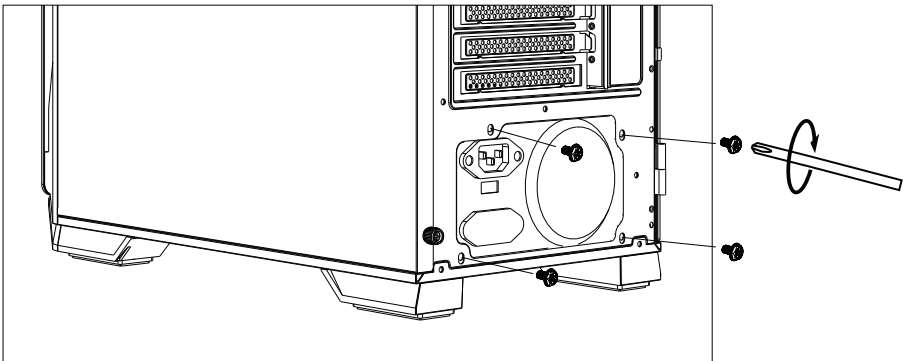

#6-32 6mm Screw

PSU and Graphics Card Mounting.

ASSEMBLY – STEPS C and D

Step C – Motherboard Installation

Make sure to align the motherboard mounting holes with the standoffs and secure them using the M3 5mm screws.



M3 5mm Screw

Motherboard / SSD



#6-32 6.5mm Screw

Motherboard Standoffs

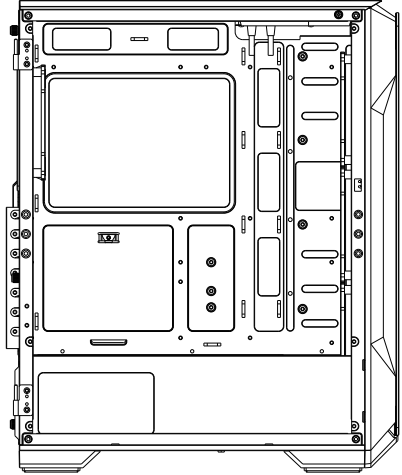

Step D – Fan Installation

Front: 3x 120mm / 2x 140mm

Rear: 1x 120mm

Top: 2x 120mm / 2x 140mm

Bottom: 1x 120mm

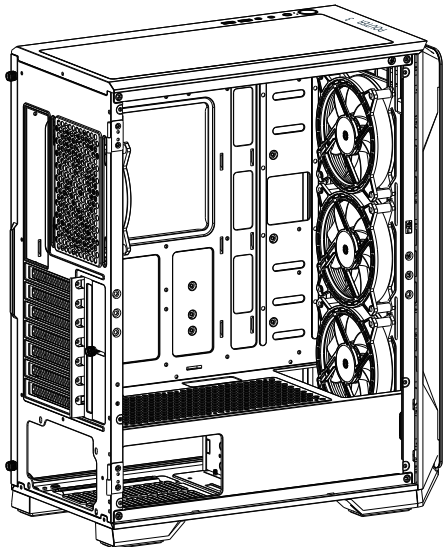

ASSEMBLY – STEP E

Step E – HDD and SSD Installation

HDD and SSD mounting bracket: Unscrew the bracket, remove it, and install the HDD or SSD using the appropriate screws.

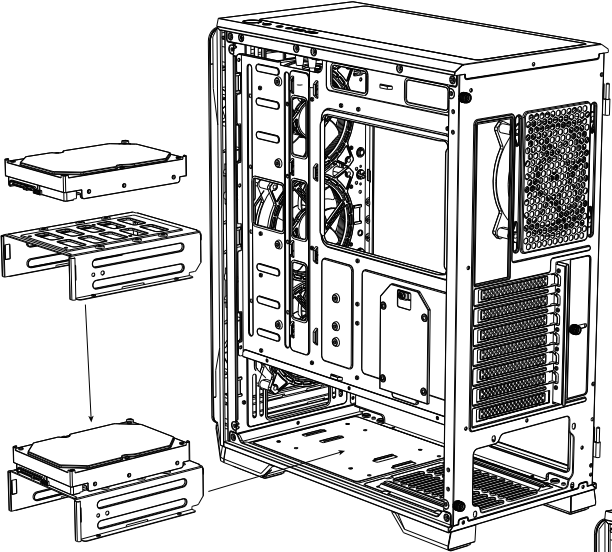

#6-32 5mmScrew

3.5" HDD

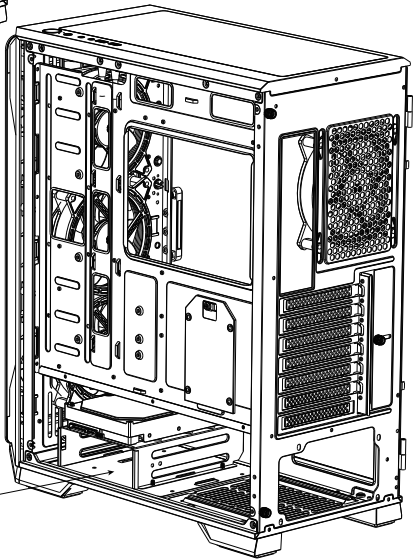
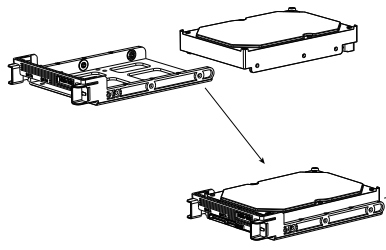

ASSEMBLY – STEPS F and G

Step F – SSD Installation

SSD mounting bracket: Remove the bracket and install the SSD using the appropriate screws.



M3 5mm Screw

Motherboard / SSD

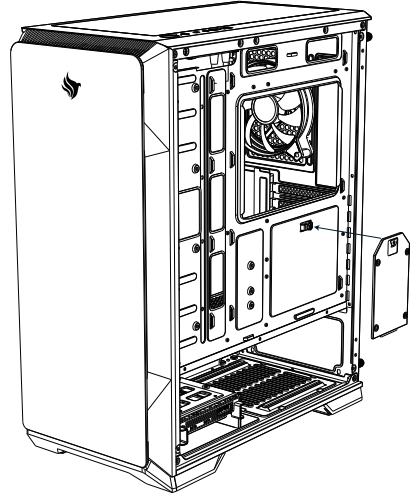

Step G – Graphics Card Installation

Identify and remove the expansion slot covers that the graphics card will occupy. Install the graphics card into the motherboard and secure it with the respective screws from the rear of the case.

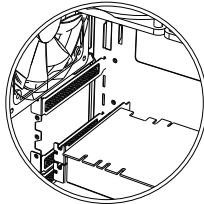
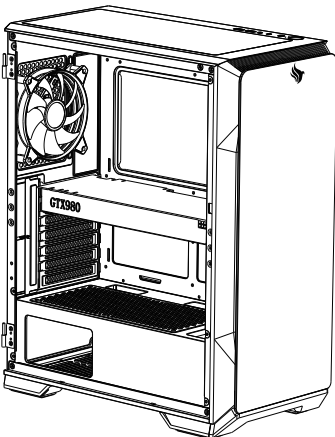

#6-32 6mm Screw

PSU or PCI-e Card Mounting.

TOP PANEL AND CONNECTORS

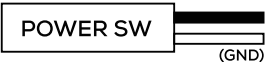
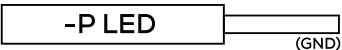
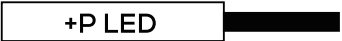
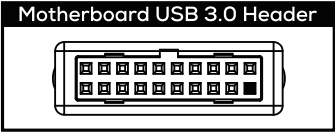
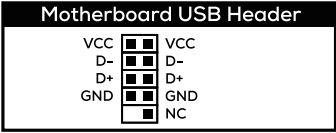
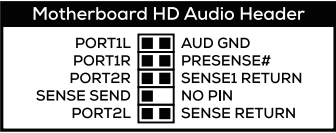
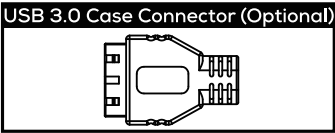
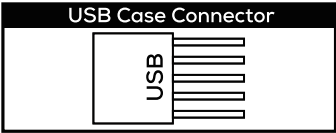
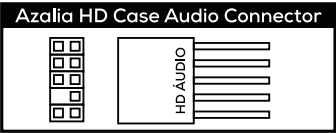
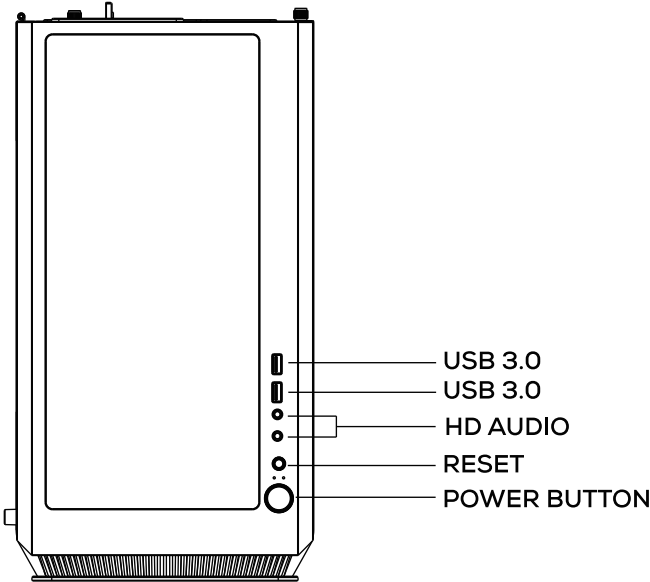

**THANK YOU FOR CHOOSING PICHAU GROUP
AS PART OF YOUR JOURNEY.**

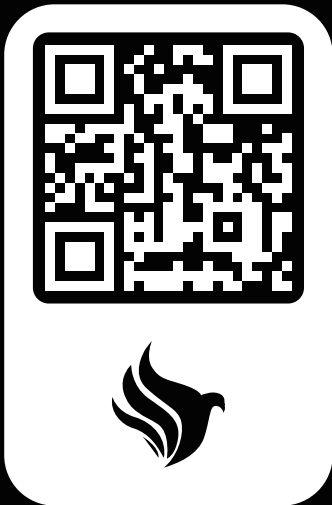

**EXPLORE OUR WEBSITES AND FIND THE IDEAL
PRODUCT TO ELEVATE YOUR EXPERIENCE.**



MANUAL DE MONTAJE

POUTER 3



IMPORTANTE

ES DE EXTREMA IMPORTANCIA LEER, COMPRENDER Y SEGUIR TODAS LAS INSTRUCCIONES CONTENIDAS EN ESTE MANUAL. LAS FALLAS OCASIONADAS POR EL MANEJO INCORRECTO PUEDEN RESULTAR EN DAÑOS AL EQUIPO Y LA POSIBLE ANULACIÓN DE LA GARANTÍA.

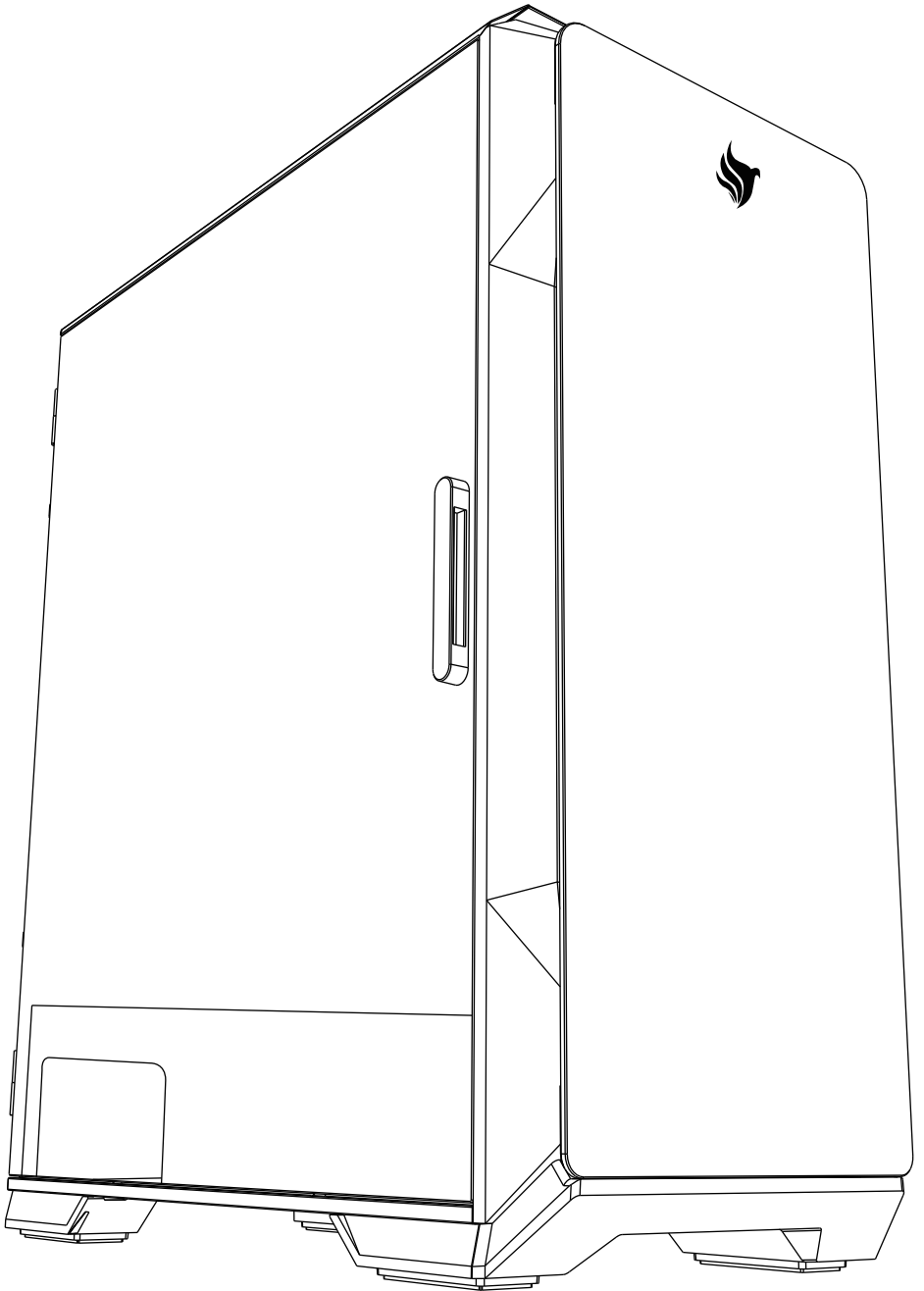

DETALLES DEL GABINETE

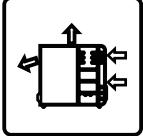
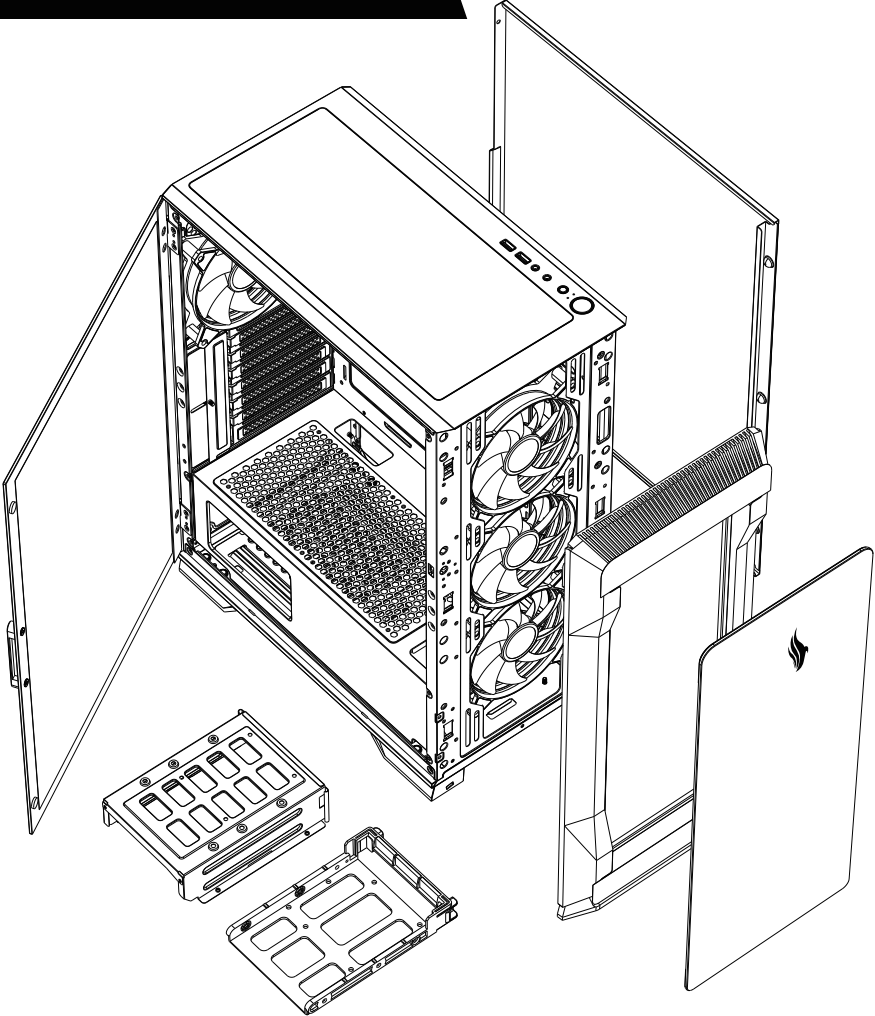

Flujo de aire optimizado

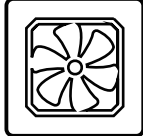

Ventiladores incluidos









Lateral de vidrio con bisagra, sin tornillos



Filtro antipolvo magnético

ACESSÓRIOS

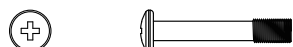
Artículo	Nombre / Cant.	Utilidad
	<p>Precintos X5</p>	<p>Gestión de cables</p>
	<p>Tornillo #6-32 10mm X2</p>	<p>Montaje de HDD</p>
	<p>Separador #6-32 6.5mm X4</p>	<p>Separadores para montaje de placa madre</p>
	<p>Tornillo M3 5mm X20</p>	<p>Montaje de placa madre o SSD</p>
	<p>Tornillo #6-32 6mm X6</p>	<p>Montaje de fuente o tarjeta gráfica</p>
	<p>Tornillo #6-32 5mm X4</p>	<p>Montaje de HDD</p>
	<p>Tornillo M3 28mm X4</p>	<p>Montaje de ventiladores</p>

MONTAJE – PASOS A y B

Paso A - Remoción de los paneles laterales y panel frontal

Primero retire los paneles laterales y luego el panel frontal.

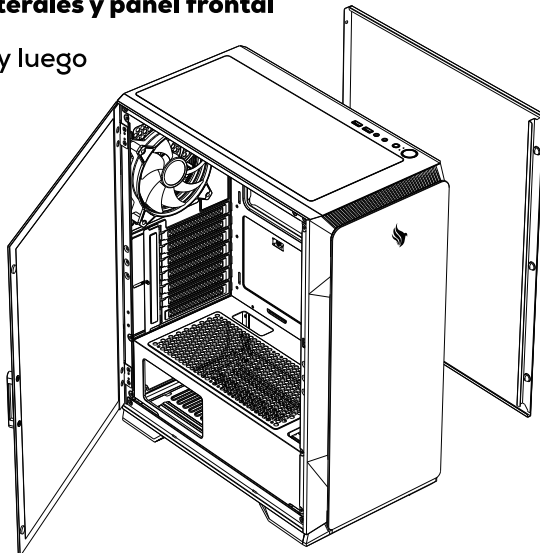

Paso B - Instalación de la fuente de alimentación

Al realizar la instalación, asegúrese de que el ventilador de la fuente esté alineado con el área designada.

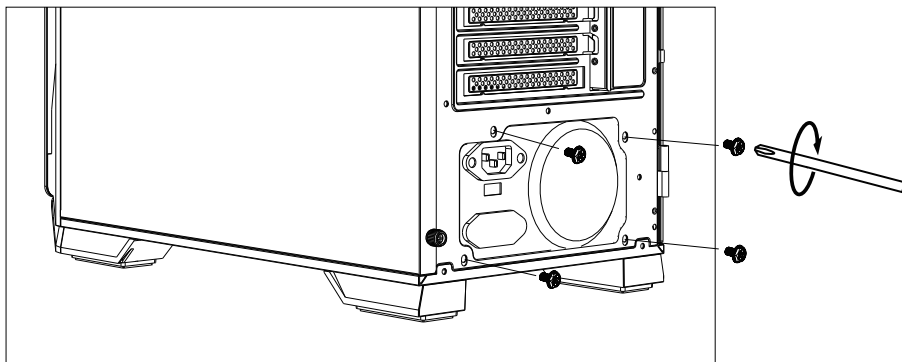

Tornillo #6-32 6mm

Montaje de la fuente y tarjeta gráfica.

MONTAJE – PASOS C y D

Paso C – Instalación de la placa madre

Asegúrese de alinear los puntos de fijación de la placa madre con los separadores y ajustar utilizando los tornillos M3 5mm.



Tornillo M3 5mm

Placa madre / SSD



Tornillo #6-32 6.5mm

Separadores para montaje
de la placa madre

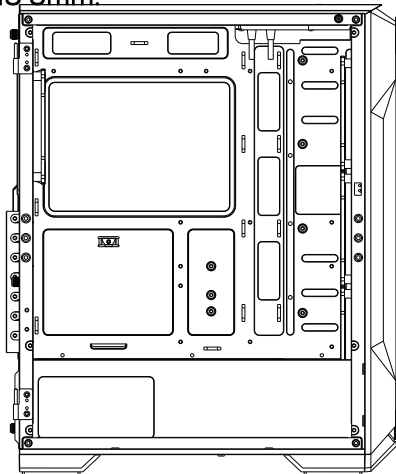

Paso D – Instalación de ventiladores

Frontal: 3x 120mm / 2x 140mm

Trasero: 1x 120mm

Superior: 2x 120mm / 2x 140mm

Inferior: 1x 120mm

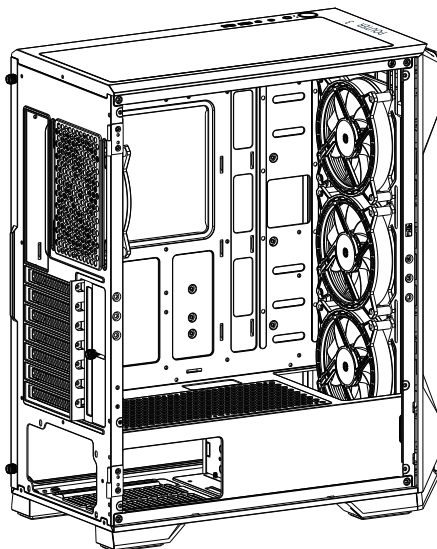

MONTAJE – PASO E

Paso E – Instalación de HDD y SSD

Soporte de montaje para HDD y SSD: Desatornille el soporte, retírelo e instale el HDD o SSD utilizando los tornillos adecuados.

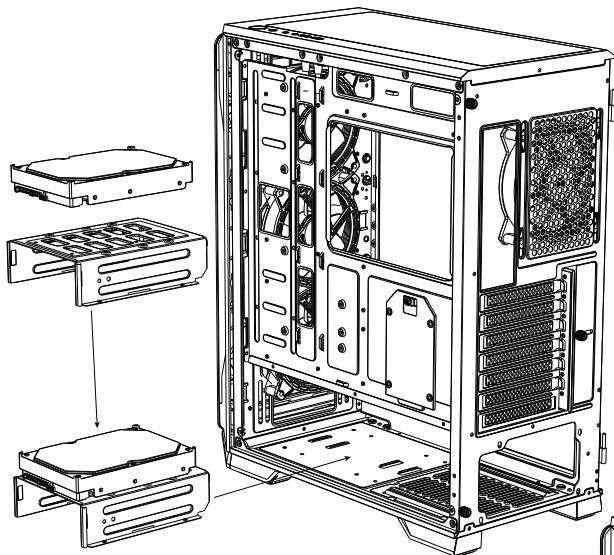

Tornillo #6-32 5mm

HDD 3.5"

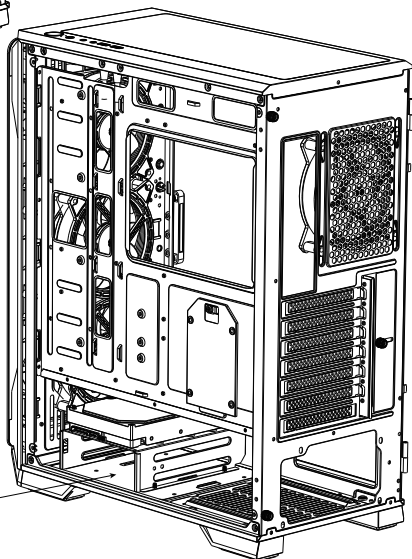
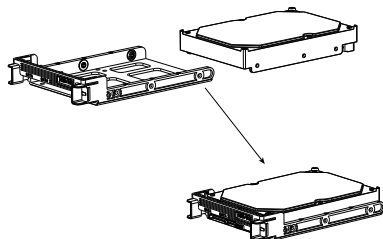

MONTAJE – PASOS F y G

Paso F – Instalación de SSD

Soporte para instalación de SSD: Retire el soporte e instale el SSD utilizando los tornillos adecuados.



Tornillo M3 5mm

Placa madre / SSD

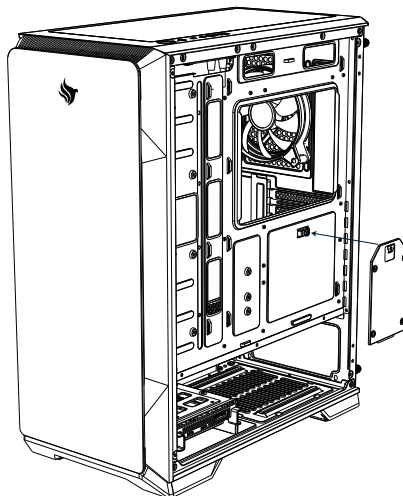

Paso G – Instalación de la Tarjeta Gráfica

Identifique y retire las tapas de las ranuras de expansión que utilizará la tarjeta gráfica. Instale la tarjeta gráfica en la placa madre y ajústela con los tornillos correspondientes desde la parte trasera del gabinete.

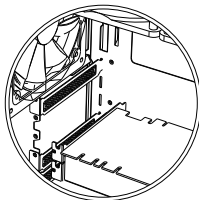
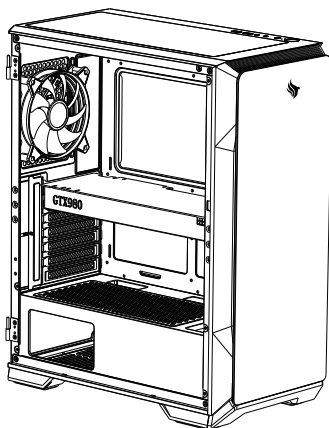

Tornillo #6-32 6mm

Montaje de la fuente o placas PCI-e.

PANEL SUPERIOR Y CONECTORES

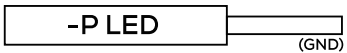
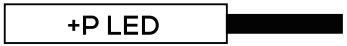
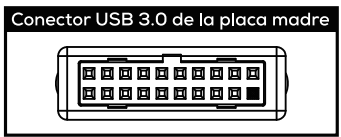
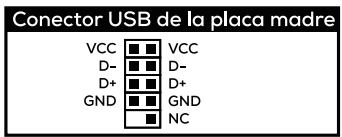
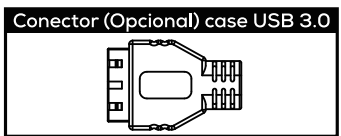
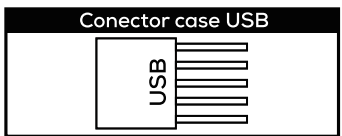
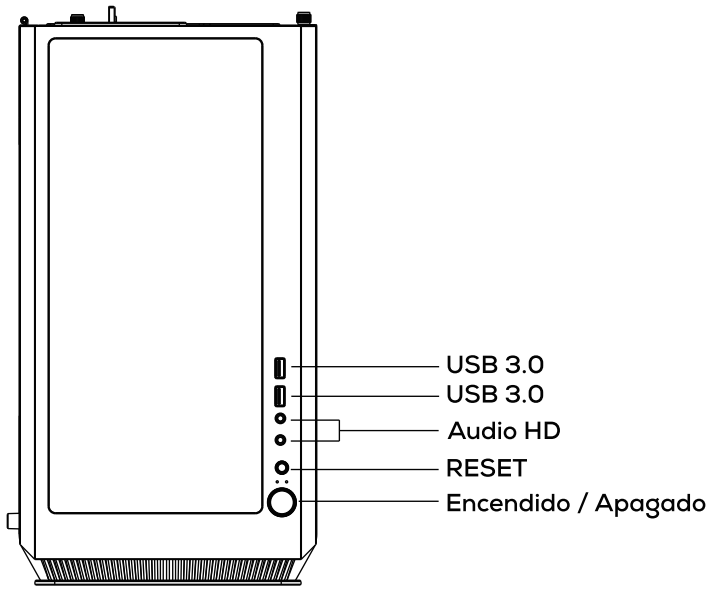

**GRACIAS POR ELEGIR A PICHAU GROUP
COMO PARTE DE SU TRAYECTORIA.**

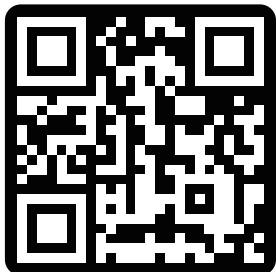

PICHAU

**EXPLORE NUESTROS SITIOS Y ENCUENTRE EL
PRODUCTO IDEAL PARA ELEVARE SU EXPERIENCIA.**

