

PORTUGUÊS

POUTER 4B





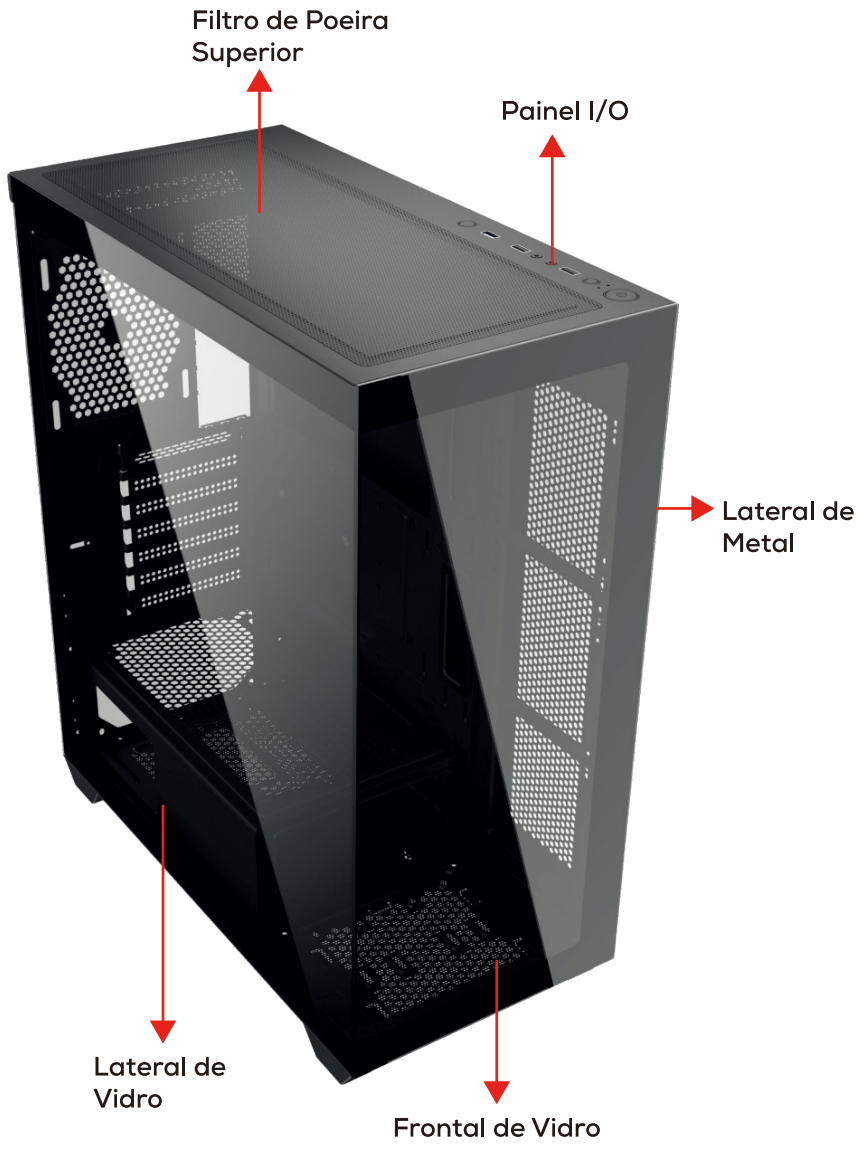

IMPORTANTE

É DE EXTREMA IMPORTÂNCIA LER, COMPREENDER E SEGUIR TODAS AS INSTRUÇÕES CONTIDAS NESTE MANUAL. O MANUSEIO INCORRETO PODE DANIFICAR O EQUIPAMENTO E OCASIONAR A ANULAÇÃO DA GARANTIA.

COMPONENTES DO HARDWARE



ACESSÓRIOS

Item	Nome/Quant.	Utilidade
	Braçadeira x5	Gerenciamento dos Cabos
	Parafusos #6-32 6mm x6	Fonte de Alimentação e Placa de Vídeo
	Parafusos M3 5mm x21	Placa-Mãe e SSD 2.5"
	Parafusos #6-32 5mm x8	HDD 3.5"
	Espaçadores #6-32 6.5mm x3	Suporte para Placa-Mãe
	Parafusos M3 28mm x1	Parafuso das Ventoinhas

ABERTURA DO GABINETE



Desparafuse e reserve os parafusos localizados na parte traseira do gabinete, remova primeiro as laterais para então remover a parte superior e a frontal

INSTALAÇÃO DA PLACA-MÃE

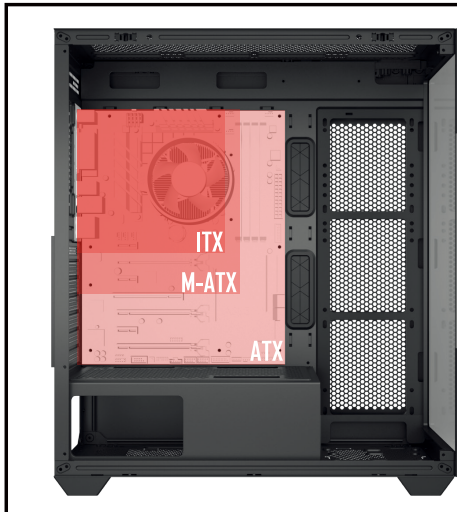

Posicione a Placa-Mãe alinhando suas furações com as do local de instalação, reposicione os espaçadores se necessário, e fixe com os respectivos parafusos.

INSTALAÇÃO DE HDD 3.5" E SSD 2.5"

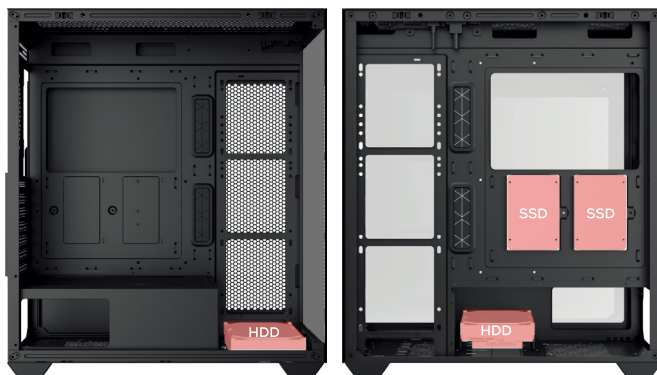

Posicione o HDD/SSD alinhando suas furações com as do local de instalação, e fixe com os respectivos parafusos.

INSTALAÇÃO DAS VENTONHAS



INSTALAÇÃO DA FONTE DE ALIMENTAÇÃO



INSTALAÇÃO DA PLACA DE VÍDEO

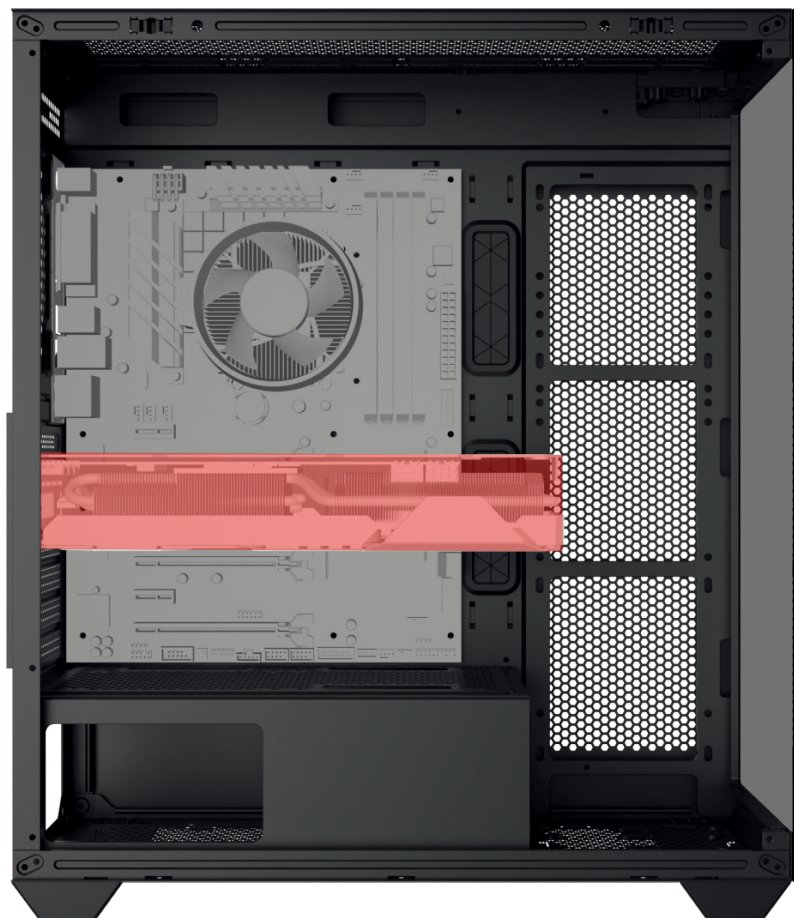

Identifique e remova os slots de expansão que o modelo da Placa de Vídeo irá utilizar, conecte a Placa de Vídeo na Placa-Mãe, e fixe com os respectivos parafusos pela parte traseira do gabinete.

PAINEL I/O

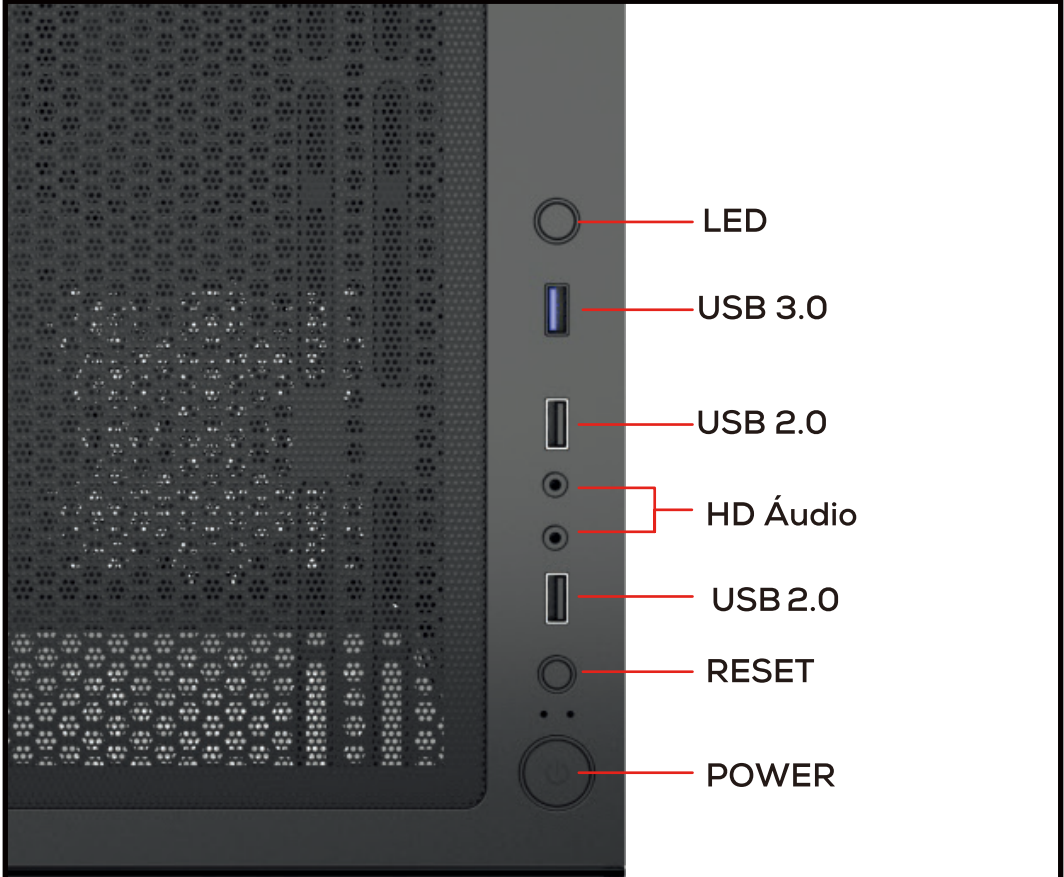

LED

USB 3.0

USB 2.0

HD Áudio

USB 2.0

RESET

POWER

CONECTORES

Conector de Áudio HD do Gabinete



Conector de Áudio HD da Placa-Mãe

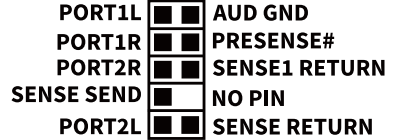

Conector USB 2.0 do Gabinete

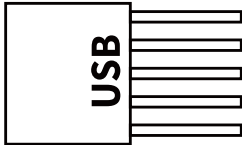

Conector USB 2.0 da Placa-Mãe

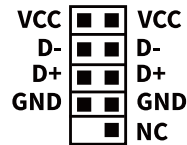

Conector USB 3.0 do Gabinete

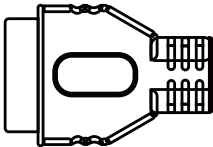

Conector USB 3.0 da Placa-Mãe

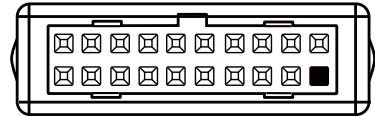

Conector Power/Reset/LED do Gabinete

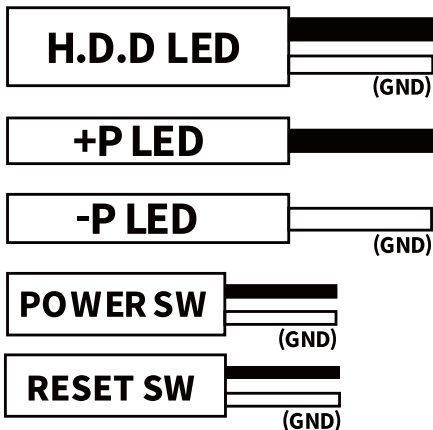

Conector Power/Reset/LED da Placa-Mãe

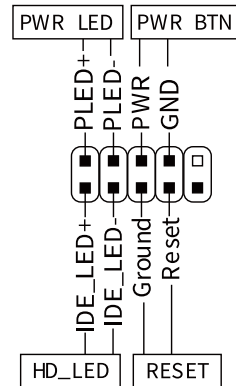

**AGRADECEMOS POR ESCOLHER O PICHAU GROUP
COMO PARTE DA SUA JORNADA.**

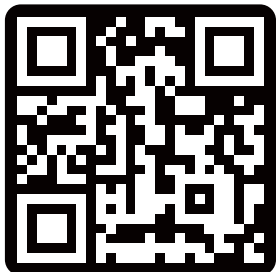

PICHAU

**EXPLORE NOSSOS SITES E ENCONTRE O
PRODUTO IDEAL PARA ELEVAR SUA EXPERIÊNCIA.**



ESPAÑOL

POUTER 4B

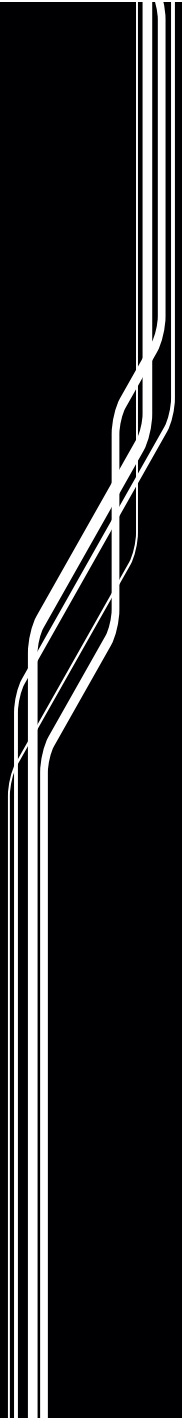





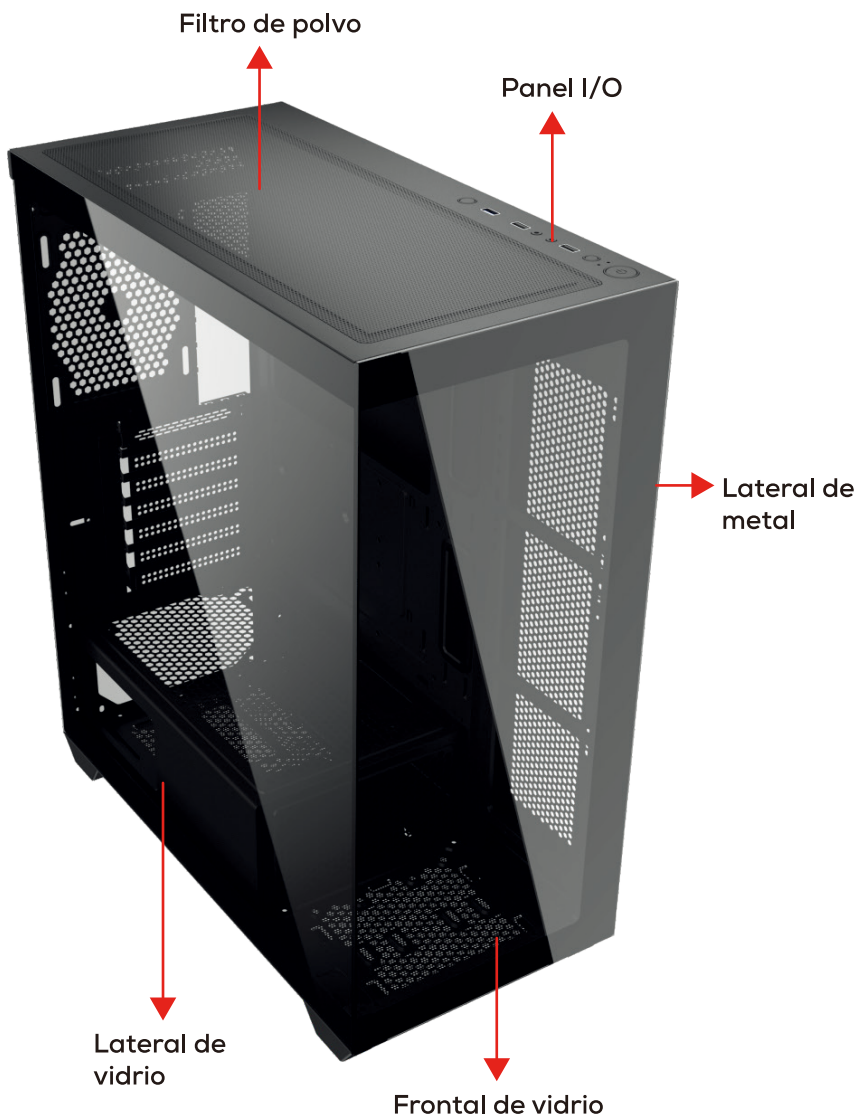

IMPORTANTE

**ES DE EXTREMA IMPORTANCIA LEER, COMPRENDER Y SEGUIR
TODAS LAS INSTRUCCIONES CONTENIDAS EN ESTE MANUAL. LAS FALLAS
OCASIONADAS POR EL MANEJO INCORRECTO PUEDEN RESULTAR EN
DAÑOS AL EQUIPO Y LA POSIBLE ANULACIÓN DE LA GARANTÍA.**

COMPONENTES DEL GABINETE



ACCESORIOS

Ítem	Nombre / Cant.	Utilidad
	Precintos x5	Organización de cables
	Tornillos #6-32 6mm x6	Fuente de Alimentación y Tarjeta de Video
	Tornillos M3 5mm x21	Placa Madre y SSD 2.5"
	Tornillos #6-32 5mm x8	HDD 3.5"
	Separadores #6-32 6.5mm x3	Soporte para Placa Madre
	Tornillos M3 28mm x1	Tornillos para ventiladores

APERTURA DEL GABINETE

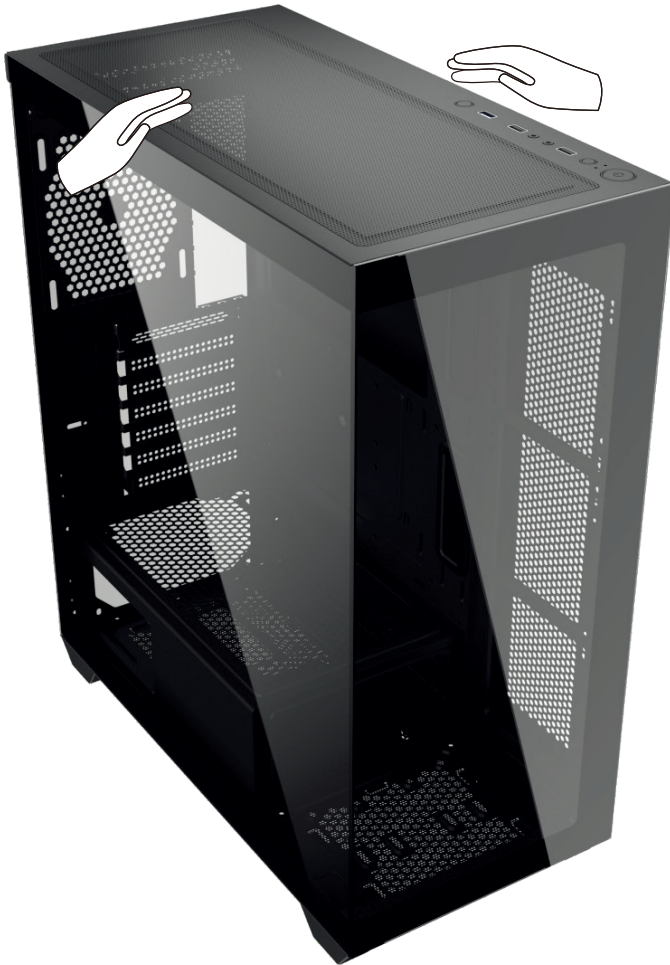

Desatornillá y reservá los tornillos ubicados en la parte trasera del gabinete. Sacá primero los laterales para después sacar la parte superior y la frontal.

INSTALACIÓN DE LA PLACA MADRE

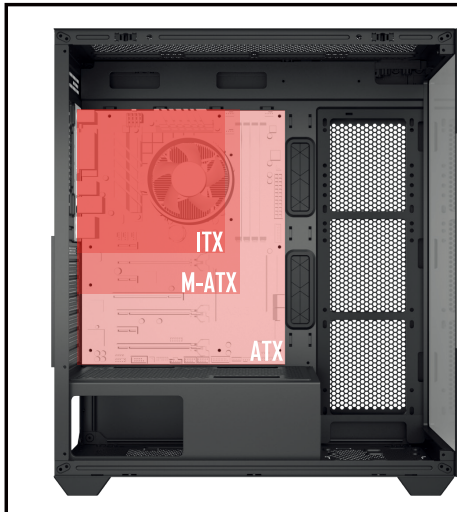

Posicione la Placa Madre alineando sus orificios con los del lugar de instalación, reposicione los separadores si es necesario y fíjela con los tornillos respectivos.

INSTALACIÓN DE HDD 3.5" Y SSD 2.5"

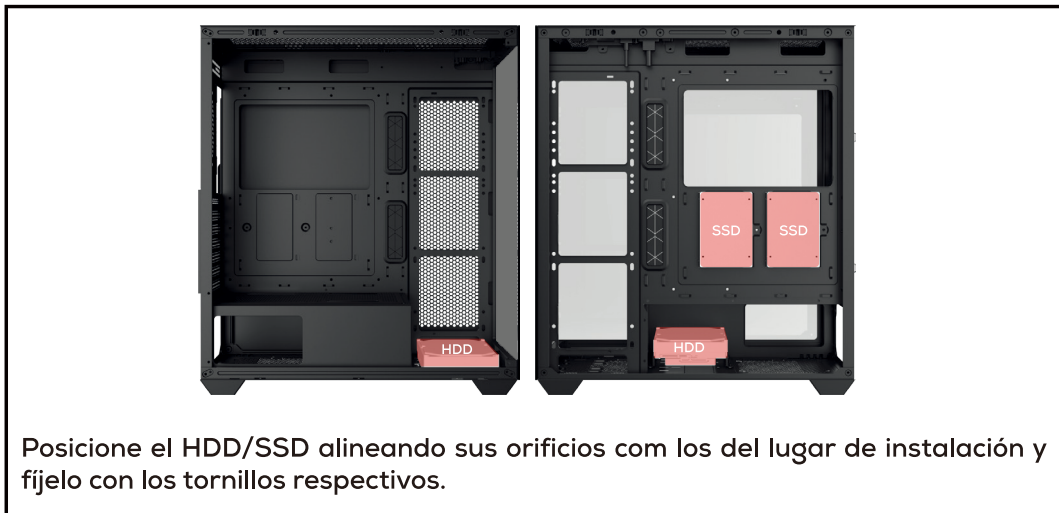

Posicione el HDD/SSD alineando sus orificios con los del lugar de instalación y fíjelo con los tornillos respectivos.

INSTALACIÓN DE LOS VENTILADORES

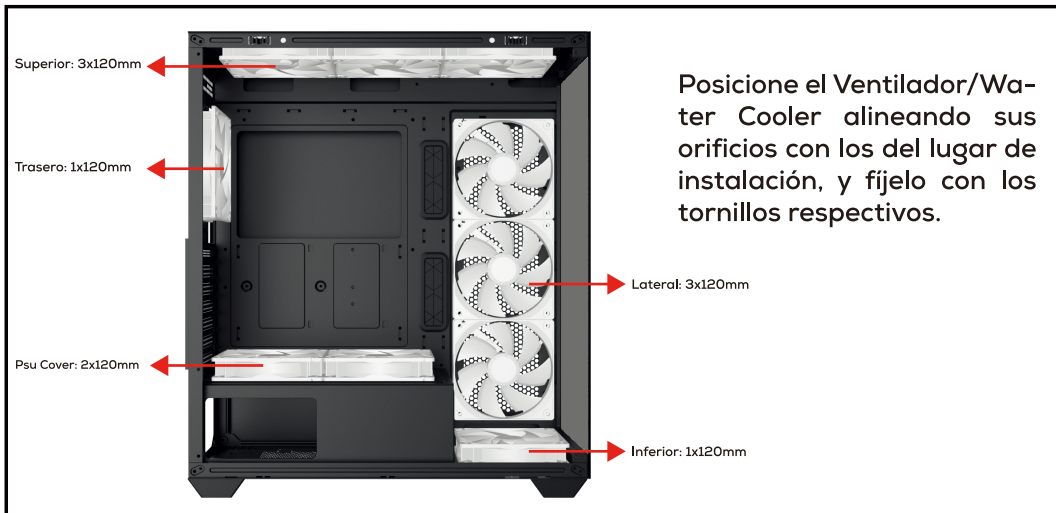

INSTALACIÓN DE LA FUENTE DE ALIMENTACIÓN



INSTALACIÓN DE LA TARJETA DE VIDEO

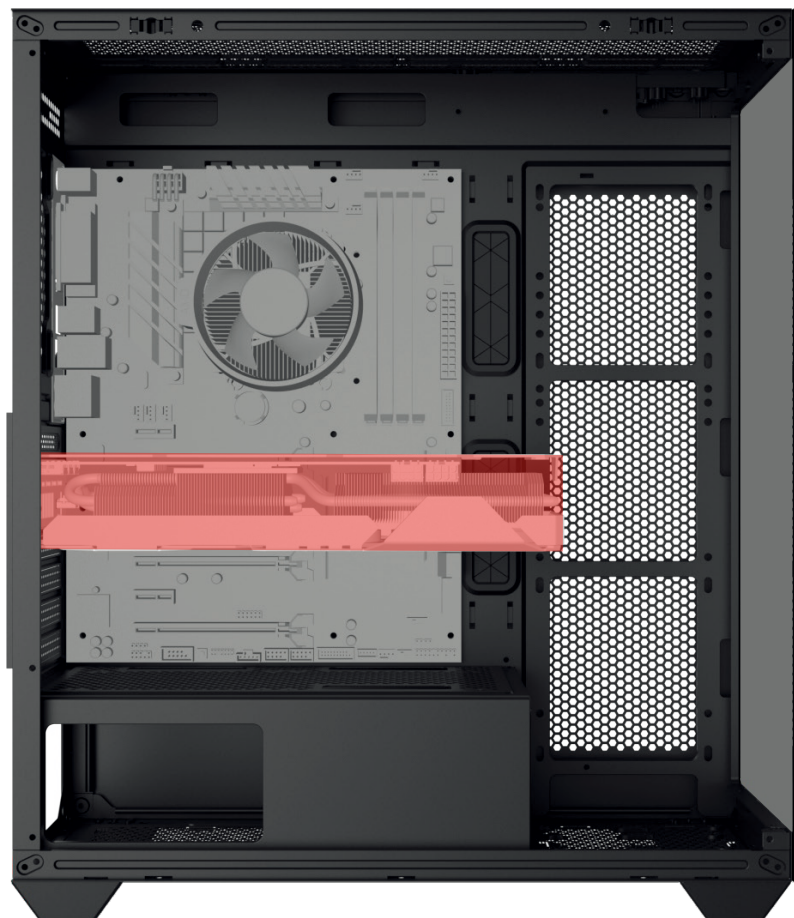

Identifique y retire las cubiertas de los slots de expansión que utilizará el modelo de su Tarjeta de Video, conecte la placa a la Placa Madre y fíjela con los tornillos respectivos por la parte trasera del gabinete.

PANEL I/O

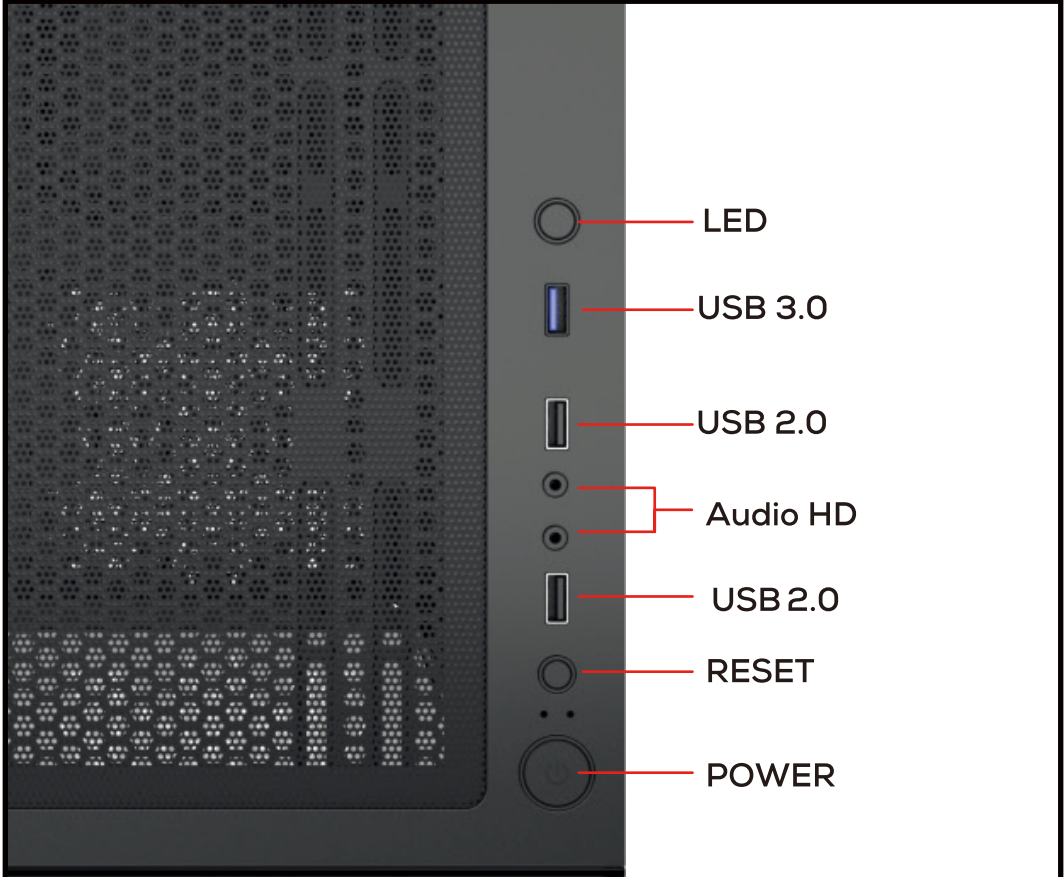

CONECTORES

Conector de Audio HD del Gabinete



Conector de Audio HD de la Placa Madre

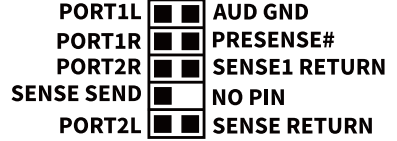

Conector USB 2.0 del Gabinete

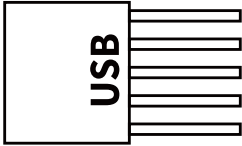

Conector USB 2.0 de la Placa Madre

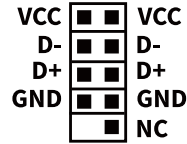

Conector USB 3.0 del Gabinete

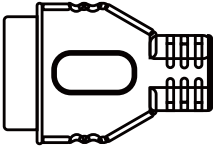

Conector USB 3.0 de la Placa Madre

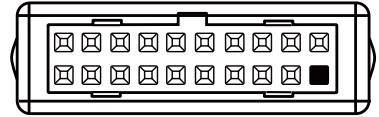

Conector Power/Reset/LED del Gabinete

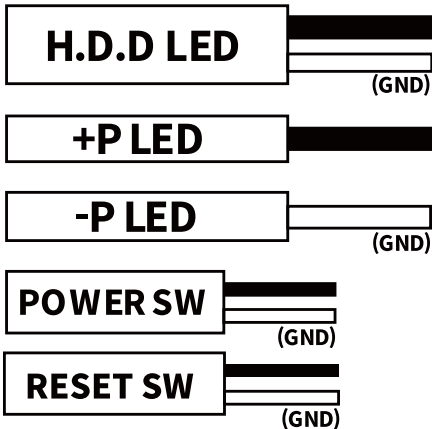

Conector Power/Reset/LED de la Placa Madre

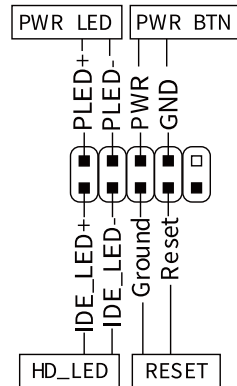

**GRACIAS POR ELEGIR A PICHAU GROUP
COMO PARTE DE SU TRAYECTORIA.**

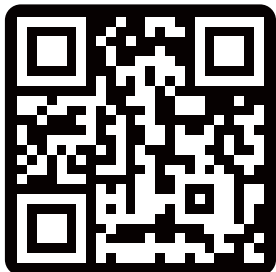

PICHAU

**EXPLORE NUESTROS SITIOS Y ENCUENTRE EL
PRODUCTO IDEAL PARA ELEVAR SU EXPERIENCIA.**

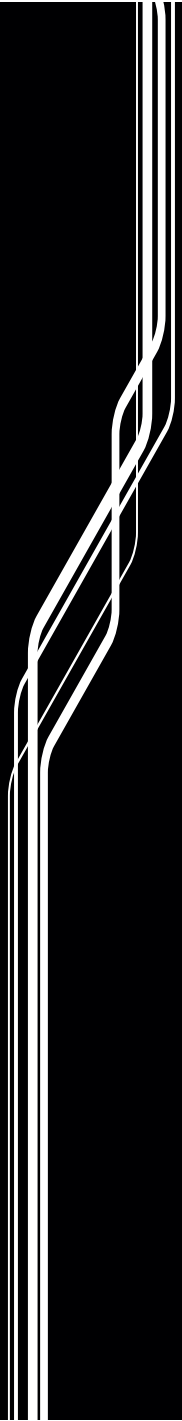

ENGLISH

POUTER 4B





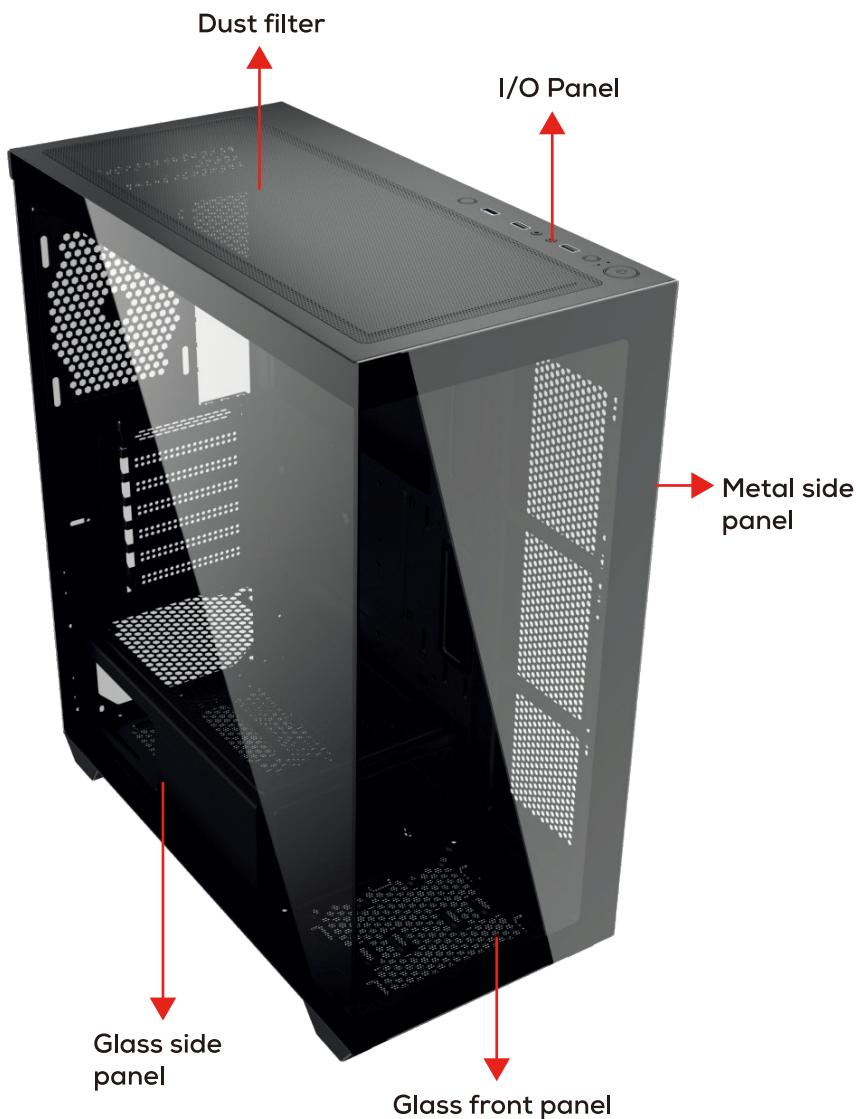

IMPORTANT

IT IS EXTREMELY IMPORTANT TO READ, UNDERSTAND, AND FOLLOW ALL INSTRUCTIONS CONTAINED IN THIS MANUAL. FAILURES CAUSED BY INCORRECT HANDLING MAY RESULT IN DAMAGE TO THE EQUIPMENT AND POSSIBLE VOIDING OF THE WARRANTY.

CASE COMPONENTS



ACCESORIOS

Item	Name / Qty.	Utility / Usage
	Zip ties x5	Cable management
	#6-32 6mm Screws x6	Power Supply and Graphics Card
	M3 5mm Screws x21	Motherboard and 2.5" SSD
	#6-32 5mm Screws x8	3.5" HDD
	#6-32 6.5mm Standoffs x3	Motherboard Support
	M3 28mm Screws x1	Fan Screws

OPENING THE CASE

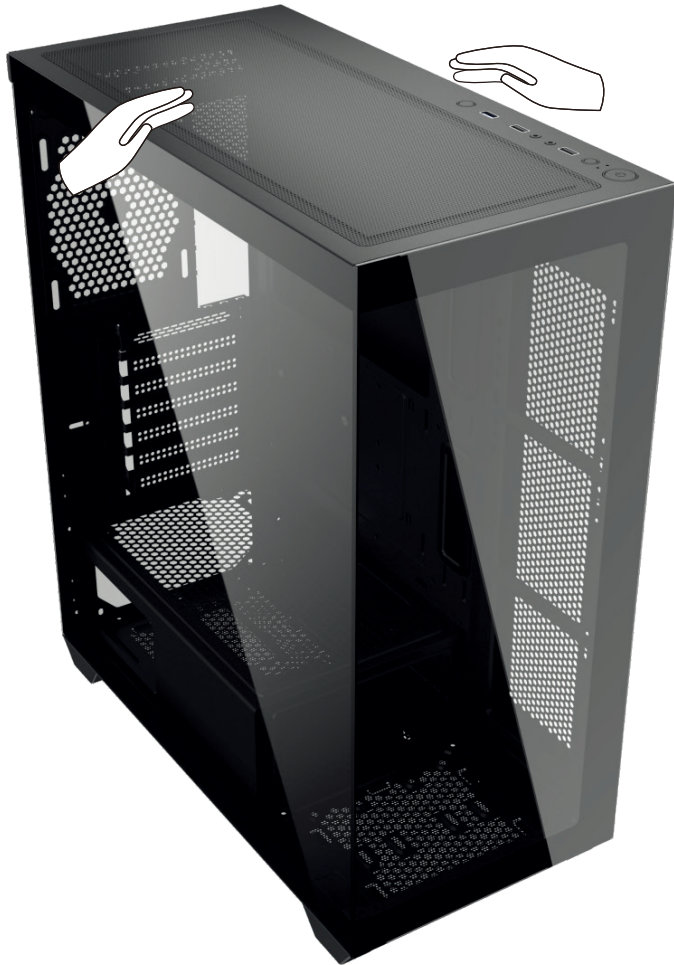

Unscrew and set aside the screws located on the rear or side of the case, then remove the side panels.

MOTHERBOARD INSTALLATION

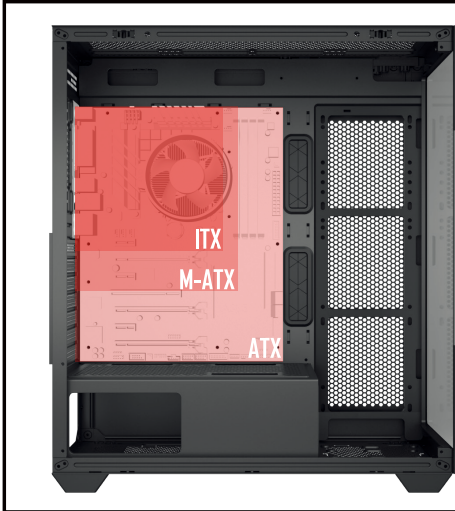

Position the Motherboard by aligning its mounting holes with those on the case, reposition the standoffs if necessary, and secure it with the corresponding screws.

3.5" HDD AND 2.5" SSD INSTALLATION



Position the HDD/SSD by aligning its mounting holes with those on the installation site, and secure it with the corresponding screws.

FAN INSTALLATION

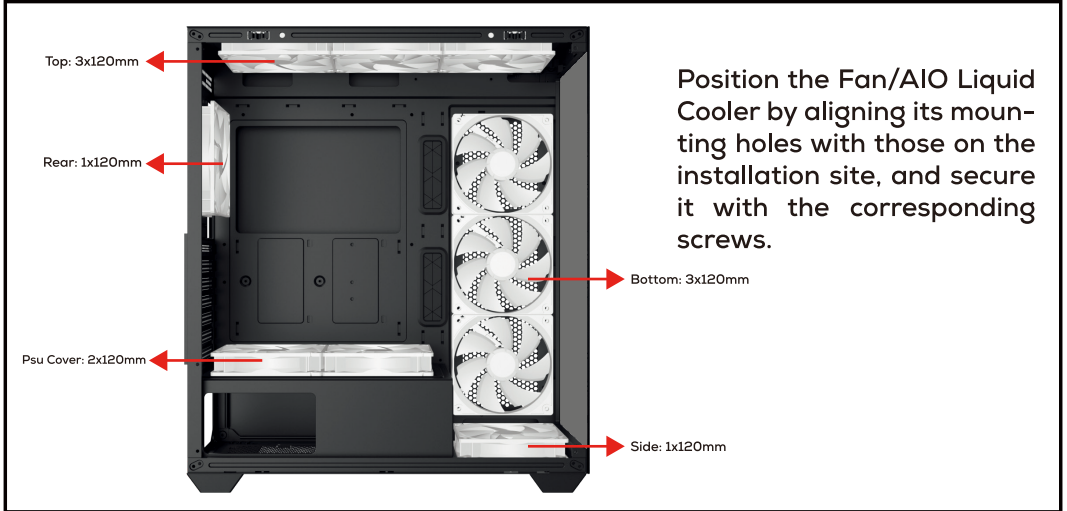

POWER SUPPLY INSTALLATION (PSU)

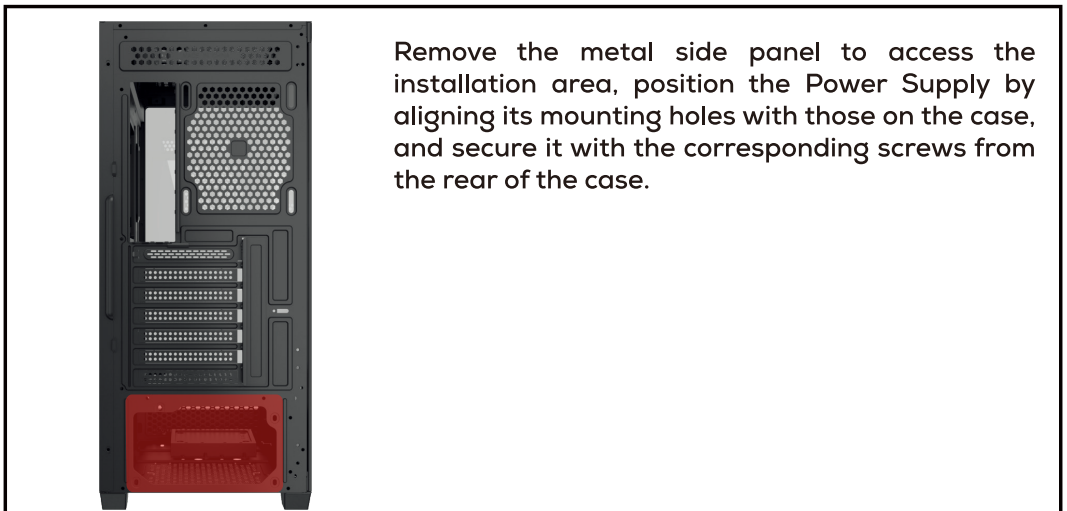

GRAPHICS CARD INSTALLATION

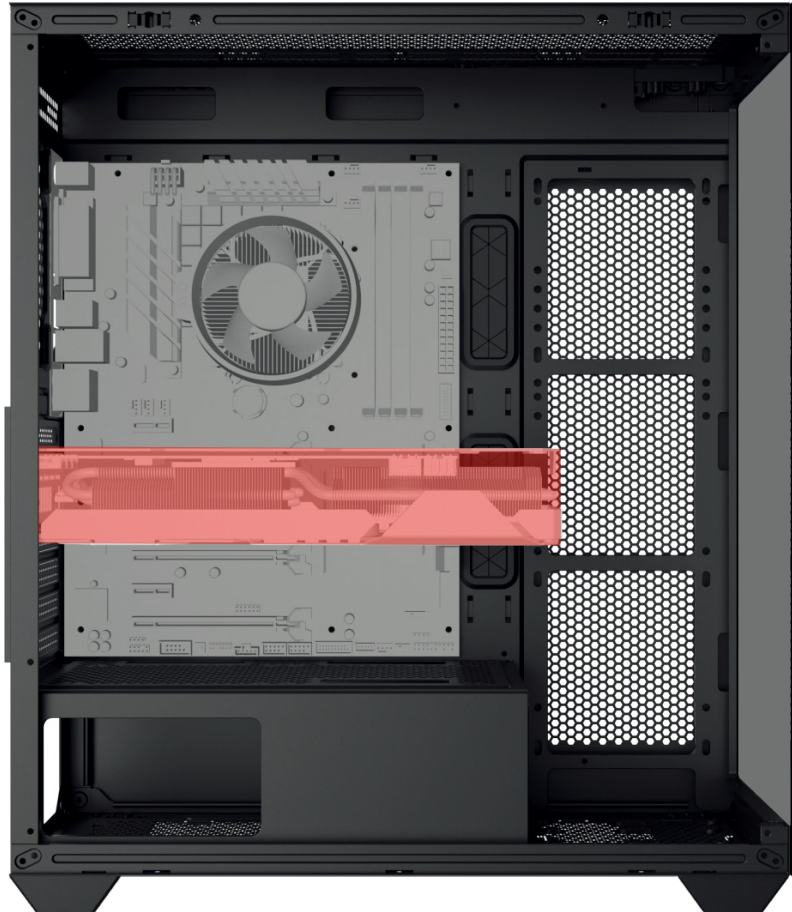

Identify and remove the expansion slot covers that your Graphics Card model will use, connect the card to the Motherboard, and secure it with the corresponding screws from the rear of the case.

I/O PANEL

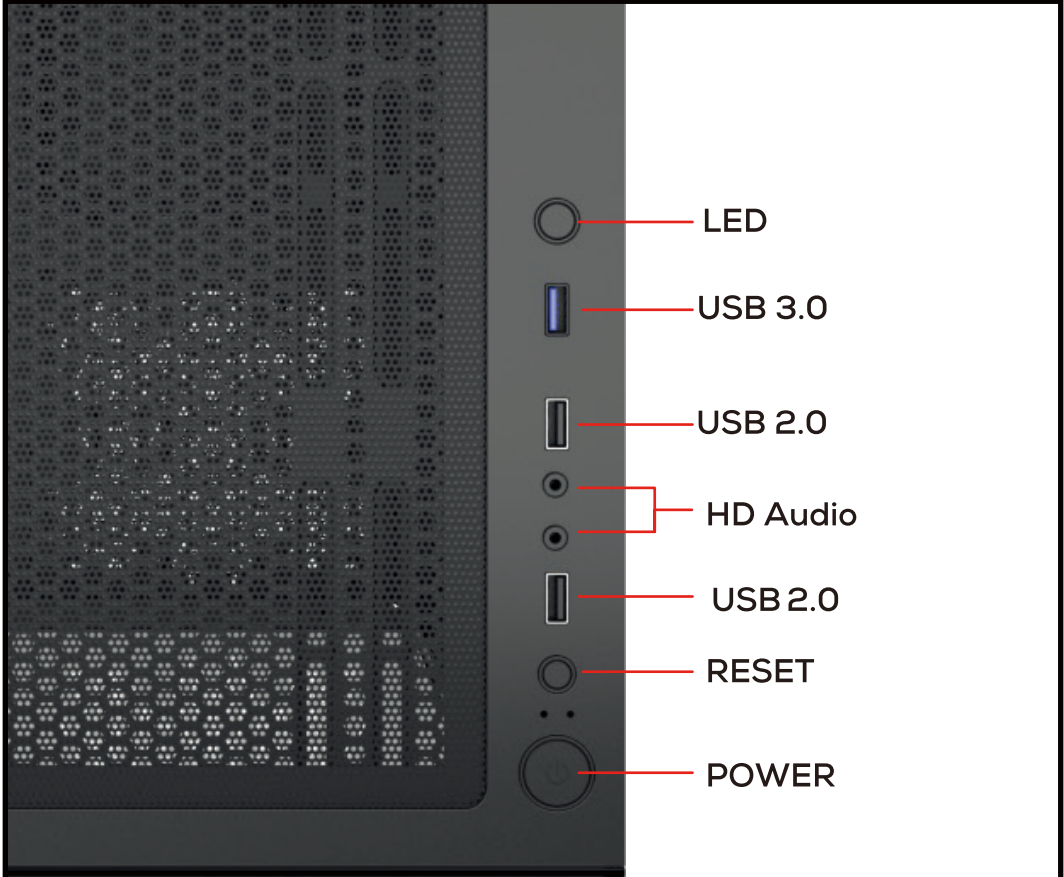

CONNECTORS

Case HD Audio Connector

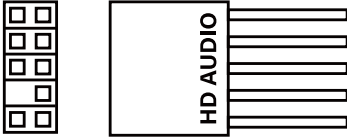

Motherboard HD Audio Connector

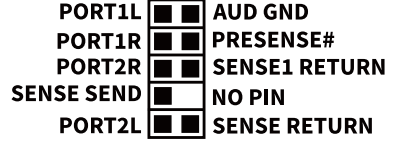

Case USB 2.0 Connector

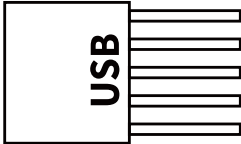

Motherboard USB 2.0 Connector

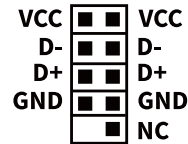

Case USB 3.0 Connector

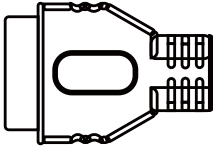

Motherboard USB 3.0 Connector

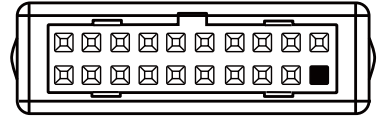

Case Power/Reset/LED Connector

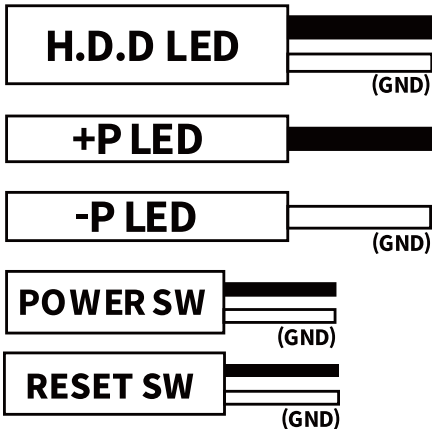

Motherboard Power/Reset/LED Connector

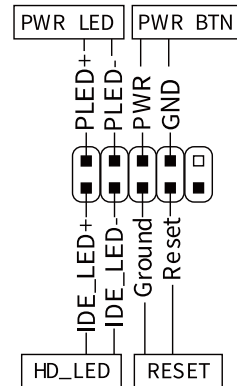

**THANK YOU FOR CHOOSING PICHAU GROUP
AS PART OF YOUR JOURNEY.**

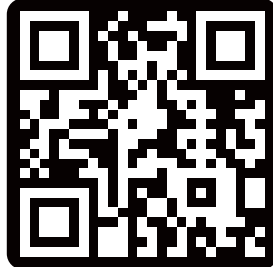

PICHau

**EXPLORE OUR WEBSITES AND FIND THE
IDEAL PRODUCT TO ELEVATE YOUR EXPERIENCE.**

